

SIMRAD

R2009/R3016

User Manual

ENGLISH



Preface

Disclaimer

As Navico is continuously improving this product, we retain the right to make changes to the product at any time which may not be reflected in this version of the manual. Please contact your nearest distributor if you require any further assistance.

It is the owner's sole responsibility to install and use the equipment in a manner that will not cause accidents, personal injury or property damage. The user of this product is solely responsible for observing maritime safety practices.

NAVICO HOLDING AS AND ITS SUBSIDIARIES, BRANCHES AND AFFILIATES DISCLAIM ALL LIABILITY FOR ANY USE OF THIS PRODUCT IN A WAY THAT MAY CAUSE ACCIDENTS, DAMAGE OR THAT MAY VIOLATE THE LAW.

This manual represents the product as at the time of printing. Navico Holding AS and its subsidiaries, branches and affiliates reserve the right to make changes to specifications without notice.

Governing Language

This statement, any instruction manuals, user guides and other information relating to the product (Documentation) may be translated to, or has been translated from, another language (Translation). In the event of any conflict between any Translation of the Documentation, the English language version of the Documentation will be the official version of the Documentation.

Copyright

Copyright © 2016 Navico Holding AS.

Warranty

The warranty card is supplied as a separate document.

In case of any queries, refer to the brand website of your display or system: navico-commercial.com/.

Regulatory statements

This equipment is intended for use in international waters as well as coastal sea areas administrated by member states pursuant to international conventions.

The R2009 and R3016 Control units comply with:

- EMC directive 2014/30/EU

Refer to the product website for the latest information about product compliance.

The relevant Declaration of Conformity is available on the product's section on the following website: navico-commercial.com/.

About this manual

This manual is a reference guide for operating, installing and configuring the software for the R2009 and R3016 Control units.

→ **Note:** This manual does not cover installation of the various antennas that can be used in these radar systems.

In addition to this manual the following documents are available for the R2009 and R3016 Control units:

- R2009/R3016 Quick Guide (988-10951-00n)
- R2009 Control unit Mounting template (988-10916-00n)
- R3016 Control unit Mounting template (988-10917-00n)

The last digit in the part numbers is the document's revision code. The latest version of all documents can be downloaded from the product website on navico-commercial.com/.

→ **Note:** Separate manuals are delivered for the R3016 12U/6X type approved radar system.

Important text conventions

Important text that requires special attention from the reader is emphasized as follows:

→ **Note:** Used to draw the reader's attention to a comment or some important information.

⚠ **Warning:** Used when it is necessary to warn personnel that they should proceed carefully to prevent risk of injury and/or damage to equipment/personnel.

Intended audience

This manual is written for system operators and installers. It assumes that the user has basic knowledge of radars, navigation, nautical terminology and practices.

Safety precautions

Safety precautions described in this section are applicable to the radar system. They are general safety precautions that are not related to any specific procedure, and they might therefore not appear elsewhere in this manual. They are recommended precautions that personnel must understand and apply during operation and maintenance of the system.

You are obliged to read these operating instructions prior to operation, and to adhere to the operating instructions in order to prevent possible danger. Prevention of danger includes that operator personnel are trained and authorized for safe operation of the equipment. We assume no liability for damage due to improper operation which could have been prevented.

The system must only be operated by persons who have passed the relevant mandatory training on the respective systems and applications. Only reading these operating instructions cannot replace such training. Persons authorized to operate, maintain and troubleshoot the system are instructed and trained by Simrad. Persons operating or servicing this radar system must be familiar with the general safety regulations and specific safety systems, and they must have passed all required training. They must have read the relevant operating instructions and manuals before starting to work.

Have these operating instructions always at hand on all relevant locations, and ensure that copies are available to all operators. Operating personnel must at all times follow all safety regulations.

During normal operation, the unit can be quickly disconnected from the main power line by turning OFF the relevant circuit breaker located on the electric switchboard.

Do not replace components or make adjustments inside the unit when the voltage supply is turned ON. Always remove power and discharge to ground a circuit before touching it. Under no circumstances should any person initiate servicing or repairing the unit except in the presence of a qualified person.

Ensure unobstructed access to all operator panels, controls, and relevant switchgear cabinets in order to enable instant response to alarms.

Whenever it is necessary to disconnect the waveguide from a radar transmitter for maintenance purpose, the transmitter output should be terminated with a matched load. If this is not possible, care should be taken. Do not stand in front of an open-ended waveguide from which power is being radiated.

→ **Note:** Main power is always present on the terminal board unless the main break from the power distribution panel of the vessel is turned off.

⚠ **Warning:** Never look down a waveguide from which power is being radiated!

Warnings

High voltage

Radar equipment includes high voltage that can cause injury or loss of life. Danger exists only when the units are opened, exposing internal circuits, as when servicing the equipment.

This radar has been carefully designed to protect personnel from possible injury from high voltages. Although every effort has been made to eliminate danger to personnel, no responsibility is accepted for any injury or loss of life suffered in connection with this equipment.

Trademarks

Navico® is a registered trademark of Navico.

Simrad® is used by license from Kongsberg.

NMEA® and NMEA 2000® are registered trademarks of the National Marine Electronics Association.

SimNet® is a registered trademark of Navico.

SD™ and microSD™ are trademarks or registered trademarks of SD-3C, LLC in the United States, other countries or both.

HDMI® and HDMI™, the HDMI Logo, and High-Definition Multimedia Interface are trademarks or registered trademarks of HDMI Licensing LLC in the United States and other countries.

Contents

9	Introduction
9	R2009 and R3016 Radar Control units
9	O2000 Controller
9	System diagrams
11	The user interface
11	Front panel and keys
12	Main panel
13	PPI symbols
13	Picture freeze indicator
14	Softkeys
14	The menu system
15	Measurements units
15	Radar palettes
16	On-screen keyboard
17	Basic operation
17	Turning the system on and off
17	Adjusting display brightness
17	Selecting radar source
17	Switching between Transmit and Standby mode
17	Adjusting the radar range
17	Using the cursor
18	Target tracking
18	Selecting speed source and stabilization mode
19	Adjusting the radar image
19	Gain
19	Rain anti-clutter
19	Sea anti-clutter
20	Tuning
21	Radar view options
21	Target trails and past position
21	Radar orientation
21	Radar motion mode
22	Offsetting the PPI center
22	Vectors
23	Cursor bearings
23	Applying default control settings
24	Target tracking
24	Managing targets
24	Defining dangerous vessels
24	Radar targets
27	AIS targets
28	Displaying target information
30	Navigation tools
30	Guard zones
30	EBL/VRM markers
32	Measuring range and bearing
34	Advanced radar options
34	Use modes
34	Radar threshold

34	Rejecting radar interference
35	Noise rejection
35	Target boost
35	Target expansion
35	Target separation
35	Fast scan
36	Installation
36	Box contents
36	Mounting location
37	Viewing angle
38	U-bracket mounting
38	Panel mounting
39	Wiring
39	Guidelines
39	Rear connections
40	Ethernet connector
40	Power connection
41	External alarm
41	NMEA 2000 backbone
42	NMEA 0183 device connection
43	Connect an external monitor
44	Software setup
44	System settings
45	Network settings
48	Radar settings
52	Own ship
54	Simulator
54	Demo mode
54	Simulator source files
54	Advanced simulator settings
56	Maintenance
56	Preventive maintenance
56	Cleaning the display unit
56	Cleaning the media port door
56	Checking the keys
56	Checking the connectors
56	NMEA Data logging
57	Software upgrades
57	Backing up your system data
58	The alert system
58	Type of alerts
58	Alert notifications
59	Acknowledging alerts
59	The Alerts dialog
60	Alphabetic alarm listing
61	Operating modes fallback
62	Terms and abbreviations
66	Spare parts and accessories
66	R2009 Options and accessories
66	R2009 Spare parts and service packs

- 66 R3016 Options and accessories
- 67 R3016 Spare parts and service packs

68 Technical specifications

70 Menu tree

71 Dimensional drawings

- 71 R2009 Control unit
- 71 R3016 Control unit

1

Introduction

R2009 and R3016 Radar Control units

The R2009 and R3016 are dedicated Radar Control units with integrated 9-inch portrait and 16-inch widescreen display. The units are compatible with a range of Simrad radar solutions, including Halo™ Pulse Compression, Broadband 3G™/4G™, and HD Digital radars.

→ **Note:** The R3016 is also used as control unit in the Category 3 type approved R3016 12U/6X Radar systems. Separate manuals are delivered for the R3016 12U/6X Radar systems.

O2000 Controller

The optional O2000 Controller can be used to remotely operate up to 4 radar control units. Separate documentation is delivered for the O2000 Controller.

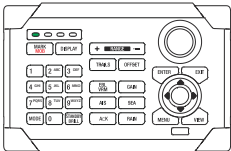

System diagrams

The images on the next pages shows examples of typical radar installations with the R2009 and R3016 control units.

- The first illustration is an example of a basic system installation with one control unit, a radar antenna, a heading sensor and a position sensor
- The second illustration shows a complex radar installation. In addition to the R3016 Control unit and sensors this has the optional O2000 Remote controller and two radar antennas connected. It is also indicated how the system can be combined with an MFD and with a second monitor mirroring the radar signal.

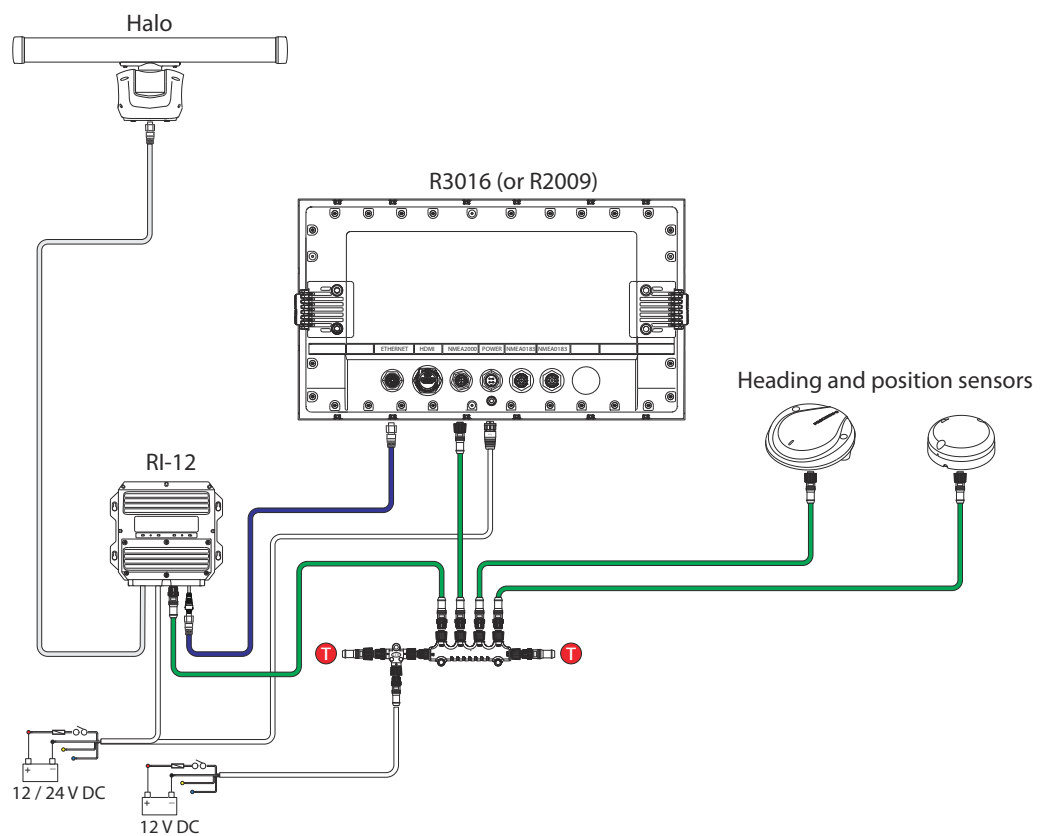

MO Monitor (repeater from 3016 only)

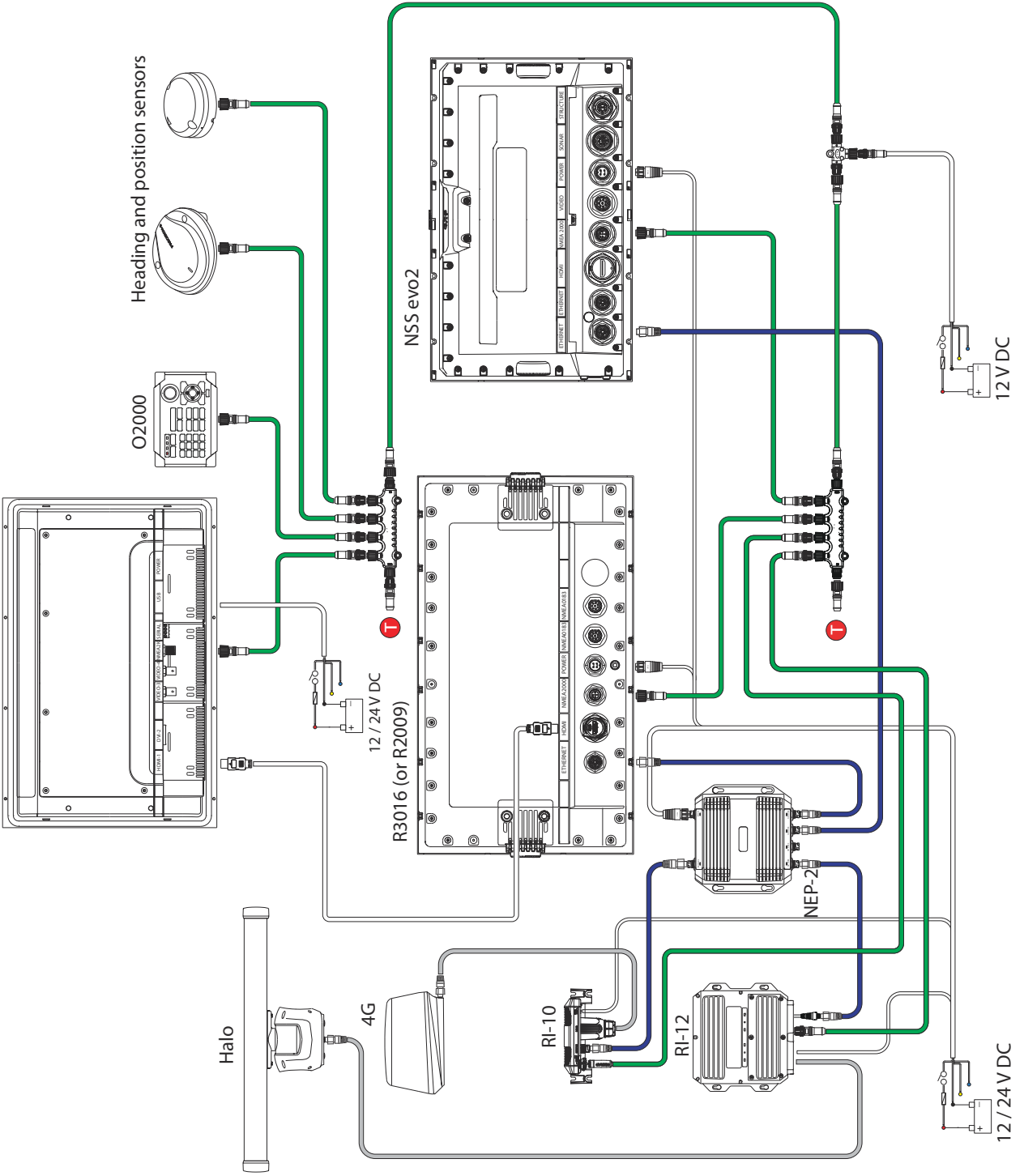

2

The user interface

Front panel and keys

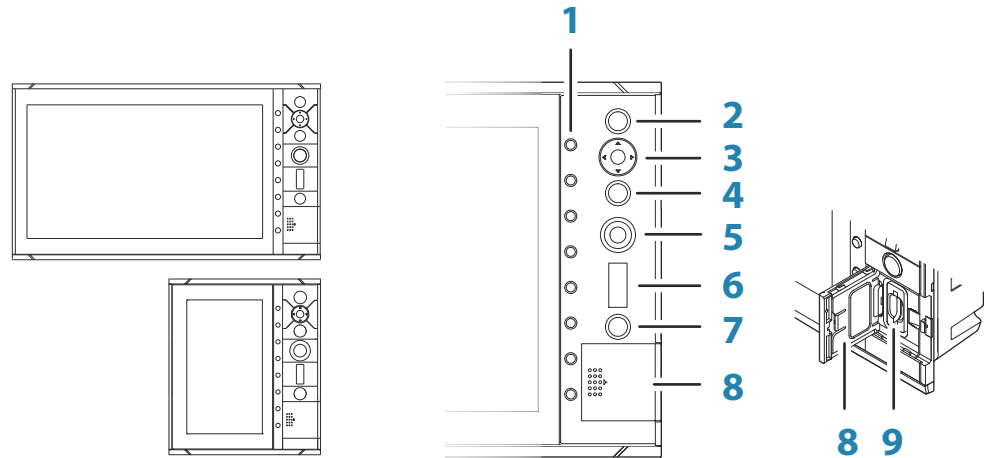

1 Softkeys

Press a key once to access options for the corresponding function.

2 Enter (ENT) key

With no menu or cursor not active: no function.

With cursor active on PPI: press to acquire a selected target, press and hold to display options for managing targets.

Menu and pop-up operation: press to select an option or activate/deactivate an option.

3 Arrow keys

With no menu active: press to move the cursor on the radar PPI.

Menu operation: press to move through menu items and to adjust a value.

4 Exit (EXIT) key

With no menu or cursor not active: no function.

With cursor active on PPI: press to remove cursor.

Menu operation: press to return to previous menu level or to exit a dialog.

5 Rotary knob

With no menu active: behavior depending on operational mode.

Menu operation: rotate to scroll through menu items and to adjust values, press to select or to save settings.

6 Range (RANGE) key

Press the + or the - indication to increase or decrease the radar range.

7 Standby/Brilliance (STANDBY/BRILL) key

Press once to display the Brilliance/Standby pop-up, press again to toggle between Standby and Transmit mode.

Press and hold to switch the radar system on/off.

8 Card reader door

9 SD card reader

Main panel

The main panel is divided into predefined areas as shown in the figure below.

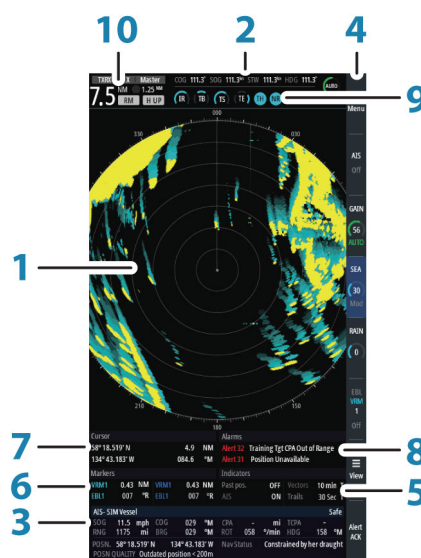

R2009

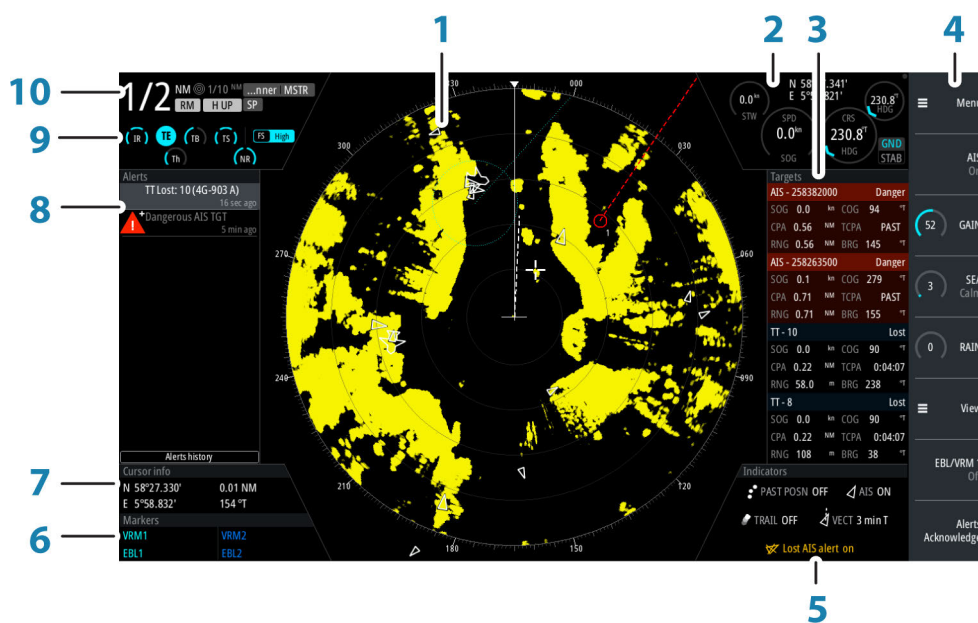

R3016

- 1 **Plan Position Indicator (PPI)**
Radar video area where all tracking and navigation options are performed.
- 2 **Own ship information**
Stabilization mode indicator, picture freeze indicator and gauges showing primary and secondary sensors.
- 3 **Target panel**
Detailed information about selected targets and AIS targets.
- 4 **Softkey bar**
Reference for softkey functions.
- 5 **Target indicators**
Overview of target indicator settings.
- 6 **Markers**
Details for active VRM and EBL markers.

- 7 Cursor information**
Range and bearing from the vessel to the cursor position. Also including position information if a position source is available.
- 8 Alerts panel**
List of all active alerts.
- 9 Signal indicators**
Gauges for signal processing and indicators for radar functions.
- 10 System information**
Range, mode and pulse details.

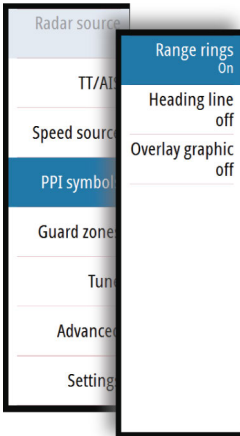

PPI symbols

Range rings and heading line symbols can be turned on and off individually from the PPI symbols sub menu.

The **Overlay graphic off** menu option turns off all graphics overlaid on the radar PPI, showing only the video signal.

→ **Note:** The **Heading line off** and **Overlay graphic off** menu options are mono stable, meaning that you need to press and hold the **ENT** key or the right arrow key to temporarily remove the relevant symbols from the panel. The graphics are invisible as long as the key is pressed, and will turn on again when the key is released.

Picture freeze indicator

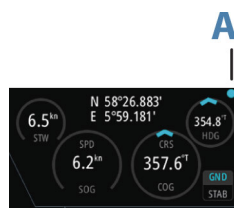

The Own ship information area includes a picture freeze indicator (A). The small dot blinks at an interval of 1 second to show that the screen is alive and that information from sensors are updated.

If the picture freezes the R3016 Control unit needs to be restarted.

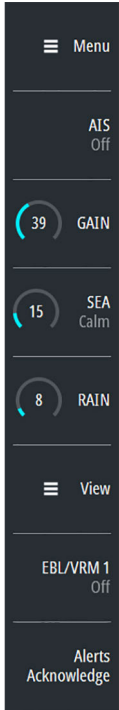

Softkeys

The softkeys are always accessible, and the softkey bar is always displayed on the radar panel. When a softkey is pressed, the function for the selected softkey becomes available.

The arrow keys, the rotary knob and the **ENT** key have different functions depending on which softkey is selected.

More details about the softkey functionality are available in the separate section describing the functions later in this manual.

Softkey pop-ups

If you press the **GAIN**, **SEA** and **EBL/VRM** softkey twice, their corresponding pop-up is displayed.

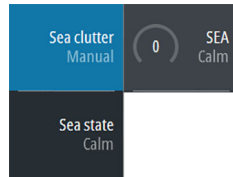

If a pop-up has more than one option, you select the options by using the arrow keys.

You remove the pop-up and revert to the softkey's main function by re-pressing the softkey, by pressing another softkey or by pressing the **EXIT** key.

The menu system

The menu system consists of the main menu with sub menus. The main menu gives access to the Settings dialogs.

If a menu is inactive for 10 seconds the menu will automatically close.

Main menu and sub menus

You access the Main menu by pressing the **Menu** softkey.

- Use the up and down arrow keys or turn the rotary knob to move up and down in a menu
- Press the **ENT** key, the right arrow key or the rotary knob to access a sub menu, to toggle options and to confirm a selection
- Press the **EXIT** key or the left arrow key to return to previous menu level and then exit the menu system

A selected menu item is indicated with a blue background. If a sub-menu is available this is indicated with a right arrow after the text.

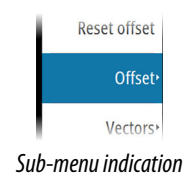
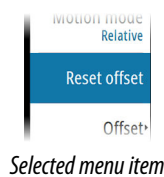
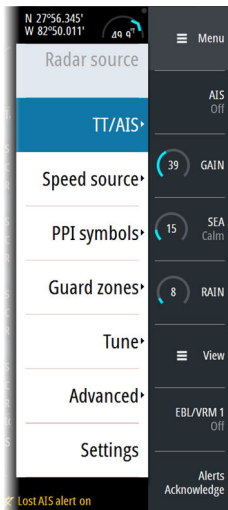

Settings dialogs

The various Settings dialogs provide access to system settings and for vessel specific settings. You access the Settings dialogs from the Main menu.

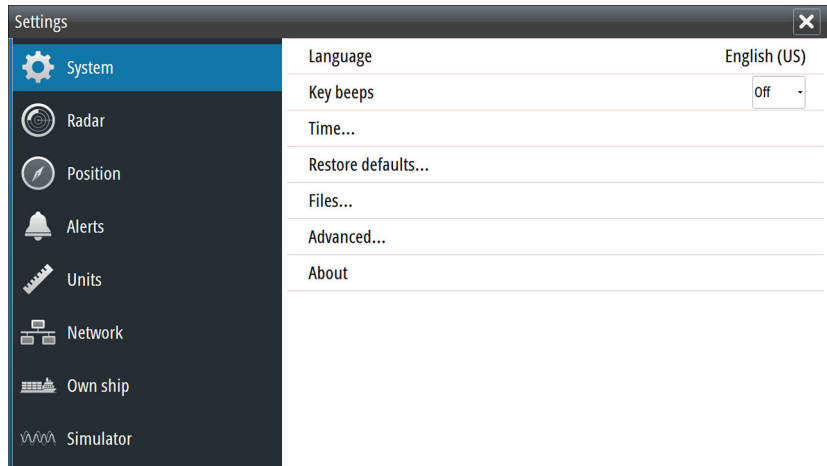
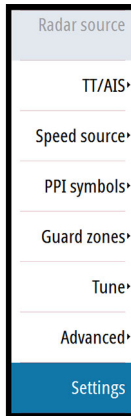

- Use the up and down arrow keys or turn the rotary knob to move up and down in a Settings dialog
- Press the **ENT** key, the right arrow key or the rotary knob to access the Settings details and to confirm a selection
- Press the **EXIT** key to close a dialog

There is no time-out for the Settings dialogs. A dialog remains open until it is manually closed.

Measurements units

You can change the measurement units from the Units Settings dialog.

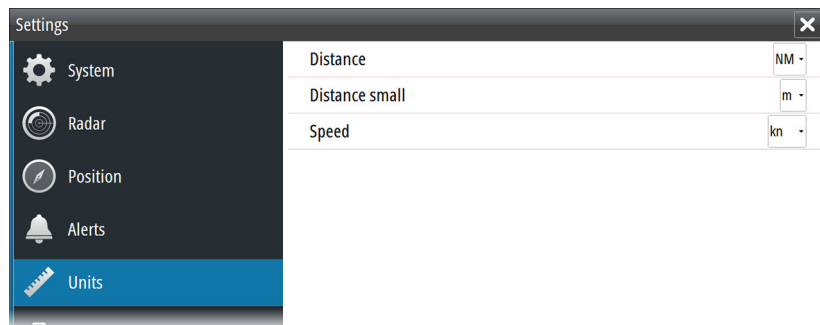

→ **Note:** Measurements units can only be changed when the connected antenna is in standby.

Radar palettes

Different palettes are available for the radar video and for the target trails. You select the palettes from the Radar Settings dialog.

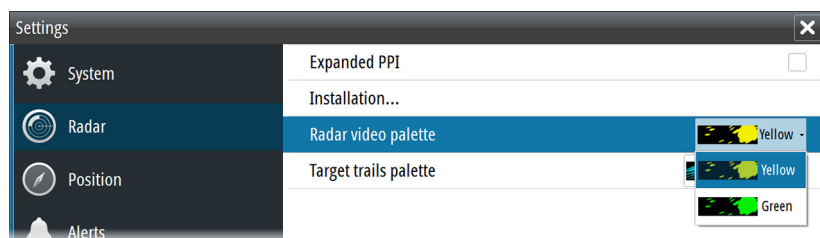

On-screen keyboard

A numeric or alphanumeric virtual keyboard is displayed when required to enter user information in dialogs.

- Select a virtual key by using the arrow keys followed by the **ENT** key to confirm the selection
- Complete the entry and close the dialog by selecting the **Enter** virtual key

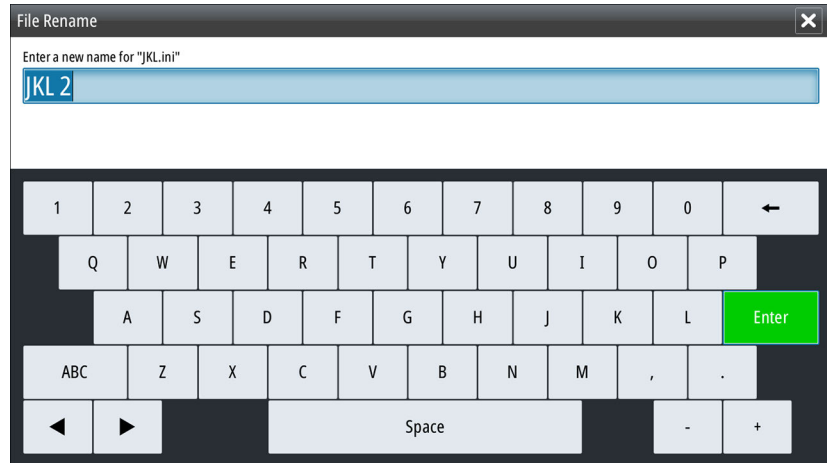

You remove the virtual keyboard without entering information by pressing the **EXIT** key.

3

Basic operation

Turning the system on and off

The system is switched ON by pressing the **STANDBY/BRILL** key on the control unit.

Press and hold the **STANDBY/BRILL** key for 5 seconds to turn the control unit and the radar antenna off

→ **Note:** The R2009 Control unit can be wired and configured for power control. If the unit is configured as a power slave, the unit will turn on and off when the power master is turned on and off. Refer to "*Power Control*" on page 45.

Adjusting display brightness

At first start-up the display brilliance is set to 100%. When the unit is restarted the brilliance is automatically set to the level it was prior to switching the unit off.

The brilliance is adjusted from the Brilliance/Standby pop-up.

- Display the pop-up by pressing the **STANDBY/BRILL** key, then adjust the display brilliance by turning the rotary knob.

The system includes a Day and a Night color palette, optimized for day and night light conditions. When the brilliance is set to 40% or lower, the system switches to use the night palette.

- With the pop-open, you switch between Day and Night palette by pressing the left (40%) or right (100%) arrow keys.

You remove the pop-up from the panel by pressing the **EXIT** key.

Selecting radar source

More than one antenna can be connected to the radar control unit.

You select active antenna from the main menu.

Switching between Transmit and Standby mode

You toggle between Transmit and Standby mode by pressing the **STANDBY/BRILL** key when the Brilliance/Standby pop-up is displayed.

Adjusting the radar range

You increase or decrease the range by one step by pressing the **+** and **-** icons on the **Range** key.

The radar range is shown in the upper left corner of the radar panel.

The range available depends on the connected radar antenna. Refer to the specifications for your radar antenna for information.

Using the cursor

The cursor can be used to measure a distance and to acquire and select targets within the PPI area.

The cursor is by default not active after power on.

- You activate the cursor and display the cursor icon by pressing one of the Arrow keys
- You move the cursor within the PPI area by pressing one of the Arrow keys
- You deactivate the cursor and remove the cursor icon from the PPI by pressing the **EXIT** key

→ **Note:** The cursor cannot be activated, deactivated or moved when a menu or a Settings dialog is open.

When the cursor is active on the radar PPI, the cursor information area will show range and bearing from the vessel to the cursor position. If the system is connected to a position source (i.e. EPFS), the cursor information area includes the geographic position of the cursor.

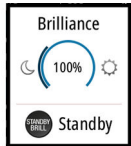

When the cursor is active the **ENT** key is used for managing targets.

Target tracking

When the cursor is active, you can use the **ENT** key for acquiring radar targets.

- Press the **ENT** key once to acquire the target at cursor position without displaying the Cursor ENTER menu
- Press and hold the **ENT** key to display the Cursor ENTER menu.

The items in the Cursor ENTER menu depends on if a target is positioned at the cursor position, the type of target, and the status of the target.



See more details about Radar targets and AIS target in *"Managing targets"* on page 24.

Selecting speed source and stabilization mode

Speed information can be obtained from different speed sources connected to the system. You can at any time switch the preferred primary speed source to any of the available speed sensors from the Speed source menu.

The stabilization mode depends on selected speed source, and the system will automatically switch to the available stabilization mode when you switch speed source.

The table shows stabilization modes available for each speed source type. Any restrictions for a source are detailed under each speed source description in the following sections.

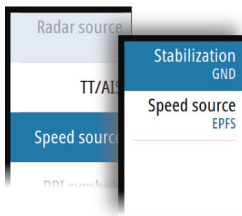

Speed source	Stabilization mode available	Restrictions
Speed LOG (Single axis)	Sea	None
Speed LOG (Dual axis)	Sea and Ground (depending on the transducer)	None
EPFS	Ground	None

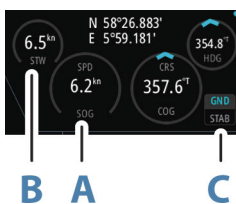

Primary speed source (**A**), secondary speed source (**B**) and stabilization mode (**C**) are shown in the Own ship information panel.

Speed LOG

The speed LOG can be Single or Dual axis input, either water track or bottom track. Therefore the stabilization mode available can be either Sea or Ground depending on the sensor in use.

EPFS

The EPFS provides True Speed and True Course Over Ground.

4

Adjusting the radar image

You may improve the radar image by adjusting the gain, by filtering out unwanted echoes due to sea clutter, rain or other weather conditions, and by tuning the sensitivity of the radar receiver.

→ **Note:** Tuning is only available for HD radar sensors.

→ **Note:** The radar image settings do not affect the AIS targets.

Sea and rain clutter could be present at the same time and further degradation in detection performance will be experienced. As sea clutter is related to short range and rain clutter is usually present in a longer range, rain clutter settings can be adjusted without affecting the echoes in the sea clutter area.

Some functions include both a manual and an automatic mode. It is recommended to use the manual mode only if the automatic mode doesn't provide satisfactory results.

The radar image is controlled by dedicated softkeys as described in the next sections.

→ **Note:** It is recommended to turn Trails OFF when you adjust the radar image as trails might hinder the proper video adjustment feedback.



Gain

The Gain option controls the sensitivity of the radar receiver. A higher gain makes the radar more sensitive to radar echoes, allowing it to display weaker targets. If the gain is set too high, the image might be cluttered with background noise.

→ **Note:** The Gain control shall not be used to clean the picture from sea or rain clutter.

The value of the Gain should be set so that the background noise is just visible on the radar panel.

At start-up of the system, the Gain is 80% in order to receive the optimum noise level.

Gain has a manual and an automatic mode.

You adjust the gain by using the **GAIN** softkey:

- Press the softkey once to activate the function, then turn the rotary knob to manually adjust the setting
- Press and hold the softkey to turn on/off the automatic option
- Press the softkey twice to display the Gain pop-up, then press the **ENT** key to turn on/off the automatic option

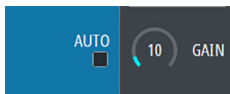

⚠ Warning: The Gain settings could compromise the proper working of the radar tracking function!

Rain anti-clutter

Rain anti-clutter is used to reduce the effect of rain, snow or other weather conditions on the radar image. When you increase the value, the sensitivity of the long distance field clutter caused by rain is reduced. The value should not be increased too much as this may filter out real targets.

Rain anti-clutter has no automatic mode.

You adjust the rain anti-clutter by using the **RAIN** softkey:

- Press the softkey once to activate the function, then turn the rotary knob to manually adjust the setting.

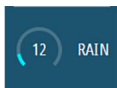

Sea anti-clutter

The Sea anti-clutter option is used to filter the effect of random echo returns from waves or rough water near the vessel. When you increase the value, the sensitivity of the near field clutter caused by waves is reduced. If the value is increased too much, both sea clutter and targets will disappear from the display and targets around own ship may not show potentially dangerous targets.

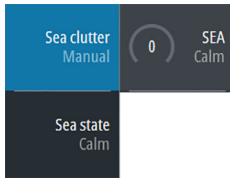

The value of the Sea anti-clutter should be set so that the clutter is seen as small dots, and small targets will become distinguishable around the ship.

Sea anti-clutter has a manual and an automatic mode, and the system includes predefined settings for Calm, Moderate and Rough sea state conditions.

You adjust the sea clutter by using the **SEA** softkey:

- Press the softkey once to activate the function, then turn the rotary knob to manually adjust the setting
- Press and hold the softkey to turn on/off the automatic option
- Press the softkey twice to display the Sea pop-up, then:
 - press the **ENT** key to turn on/off the automatic option
 - use the arrow keys to select the Sea state option, then press the **ENT** key to toggle through the predefined sea state conditions

Tuning

→ **Note:** Tuning is only required for HD radar sensors.

You can tune the radar receiver to have maximum target returns on the screen.

Tuning has a manual and an automatic mode.

In automatic tuning mode, the transceiver performs a tuning of the receiver when the range scale changes.

Manual tuning should only be used if the automatic tuning fails. The tuning should not be performed earlier than 10 minutes after the radar has been switched on. Manual tuning is best done by a long pulse setting (range set to 24 NM), and by using a high level of gain. In this condition, adjust the tuning control to obtain the maximum signal strength.

You adjust the tuning from the Tune sub-menu.

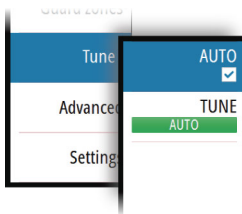

5

Radar view options

Several radar view options are available from the View sub menu, activated by pressing the **View** softkey.



Target trails and past position

You select how the radar targets are displayed on the radar image in the Trails and past position sub menu. See *"Display settings for radar targets"* on page 25.

Radar orientation

Selected radar orientation is shown in the System information panel (A).

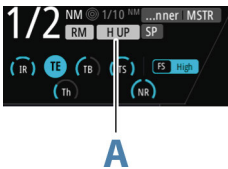

Head-up

In Head-up mode the heading line on the PPI is oriented on the 0° on the bearing scale and towards the top of the screen. The radar image is displayed relative to own ship, and when the ship turns the radar image rotates.

→ **Note:** Head-up is only available in Relative motion mode, and it is the only orientation mode available if the radar is not connected to a heading source.

North up

In North up mode the 0° indication on the PPI represents north. The heading line on the PPI is oriented according to own ship heading obtained from the gyro compass. When the ship turns the heading line changes its direction according to the ship's heading, while the radar image remains stabilized.

The North up orientation is not available if no heading source is connected to the radar. If heading data is lost, the system will automatically switch to Head-up rotation.

Course up

In Course up mode, own ship's course is oriented on the 0° on the bearing scale. When the ship turns the radar image remains its orientation, while the heading line rotates.

The Course up orientation is reset by re-selecting the Course up mode.

Radar motion mode

Selected radar motion mode is shown in the System information panel (B).

Relative motion

In Relative motion your vessel remains in a fixed location on the Radar PPI, and all other objects move relative to your position.

You select the position of the fixed location as described in *"Offsetting the PPI center"* on page 22.

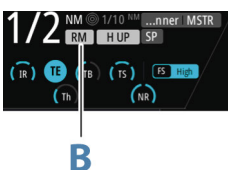

True motion

In True motion your vessel and all moving targets move across the Radar PPI as you travel. All stationary objects remain in a fixed position. When the vessel's symbol reaches 75% of the PPI radius (**A**), the radar image is redrawn with the vessel symbol re-positioned (**B**) 180° opposite the current heading bearing.

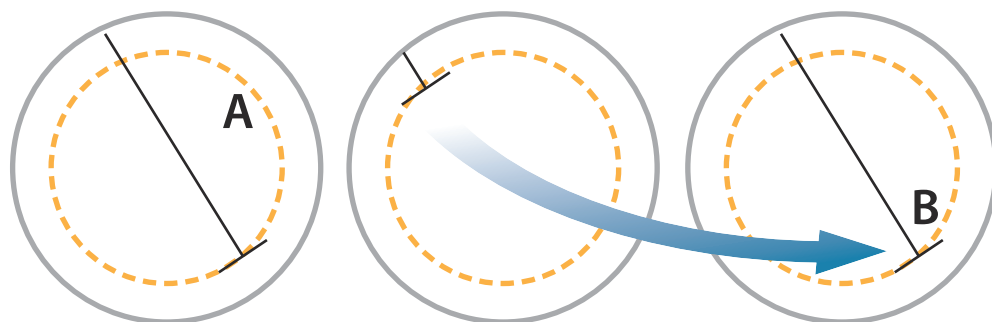

When True motion is selected, the True motion reset option is available from the menu. This allows for manually resetting the radar image and vessel symbol to its starting position.

→ **Note:** True motion is only available when the PPI is in either North Up or Course Up orientation mode.

Offsetting the PPI center

You can set the antenna position origin to different location on the radar PPI. The options described in the next sections are available.

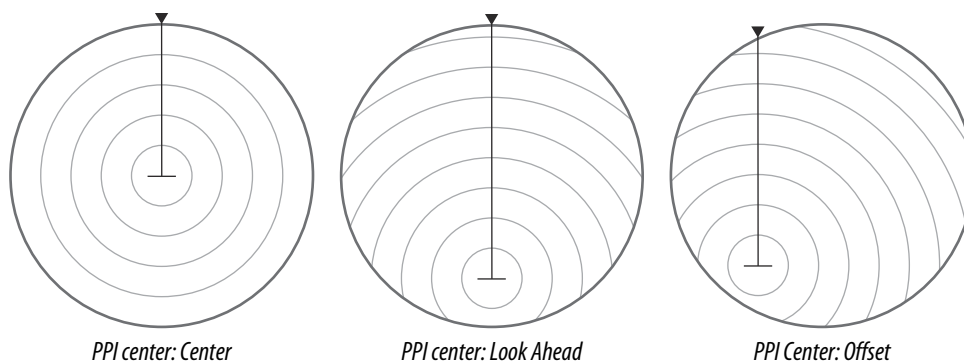
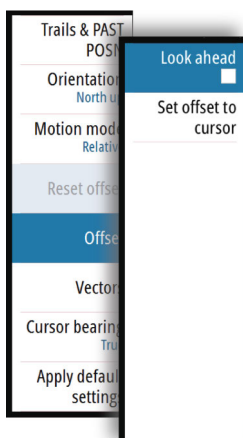

You return the antenna center to PPI center by using the **Reset offset** option in the View menu.

Center

The Center option resets the antenna position to the center of the PPI.

Look ahead

The Look ahead option is used to maximize the view ahead of the vessel. When selected the antenna center is placed at 70% of the radius of the PPI, 180° opposite the top of the display.

Offset to cursor position

This option allows you to use the cursor for selecting the antenna center. When the option is selected the PPI center is immediately moved to the cursor position.

Vectors

A target vector indicates the expected target movement within a defined time. The vectors are computed by multiplying the target speed with the set time value.

You can select to show target vectors with true or relative speed, and you can set the length of the vector. The length represents the vessel movement within the given time period.



Vector settings are shown in the Target indicators panel (A).

→ **Note:** True speed indication is not possible if there is a Gyro or Speed source failure. If the vectors are in true presentation and one of the sensors (gyro or speed log) fails, the presentation is automatically switched to relative.

Cursor bearings

You can select to show the cursor bearings as True or Relative to own vessel.

→ **Note:** True can only be selected when a gyro is available.

Applying default control settings

The default control settings allows for quickly setting the system back to a known state.

The default parameters are:

Function	Default setting
Vector	Mode - relative; time - 6 min
Target trails	Mode - relative; time - 6 min
Collision warning	CPA - 2 NM; TCPA - 12 min
VRM EBL	One EBL/VRM, EBL - 0.25 NM; VRM - 0
Range	6 NM
Range rings	Off
Orientation	North up
Motion mode	True
Off-centering	Look ahead
Speed source	EPFS; Stabilization - Ground
Past position	Off
AIS	On

6

Target tracking

Radar targets and AIS targets are used to estimate the relative speed and direction, and the system can alert the user about potentially dangerous targets and loss of communication with an AIS target.

Managing targets

When the cursor is active, you can use the **ENT** key for acquiring radar targets.

- Press the **ENT** key once to acquire the target at cursor position without displaying the Cursor ENTER menu
- Press and hold the **ENT** key to display the Cursor ENTER menu.

The items in the Cursor ENTER menu depends on if a target is positioned at the cursor position, the type of target, and the status of the target.



Selecting and de-selecting targets

AIS targets and tracked radar targets can be selected, but only one target can be selected at a time. When a target is selected the target symbol will change to selected target, and the Targets panel will show detailed information for the target.

You de-select a target and remove the detailed target information in the Target Panel by selecting the deselect target option in the Cursor ENTER menu.

Defining dangerous vessels

You can use the CPA (Closest point of approach) and TCPA (Time to closest point of approach) values to define when a target should be considered as dangerous. When a radar or AIS target comes within this distance, the symbol changes to the “dangerous” target symbol.

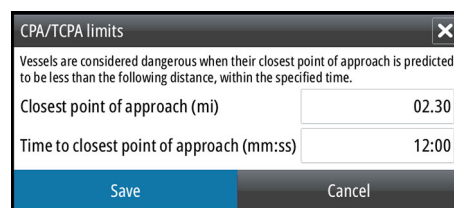
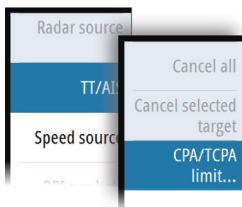

Radar targets

Any radar echo can be acquired and tracked.

Acquiring radar targets

The acquire target option is used for acquiring any targets within the radar range.

To start tracking a radar target, move the cursor to the target and then either:

- Press the **ENT** key once to acquire the selected target without displaying the Cursor ENTER menu
- Press and hold the **ENT** key to display the Cursor ENTER menu, then select the **Acquire target** menu option

There will be a delay after having selected the target before the system received stable target data:



- After 1 minute the symbol will show a trend vector, and speed and course of the trend will be shown in the Target panel

- After 3 minutes the symbol will become steady, and all the data fields of selected targets will be available. The target symbol will change to tracked radar target symbol

→ **Note:** The CPA/TCPA anti-collision functions will be enabled for tracked radar targets.

Radar target symbols

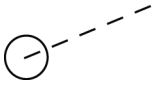
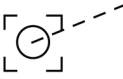
The following symbols are used for radar targets in the system:

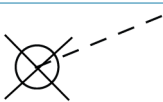
Symbol	Description
	Tracked Radar target with velocity vector.
	Selected Radar target , indicated with a square (dotted line) around the target symbol.
	Dangerous Radar target indicated with bold line and with red color. The symbol flashes until the target alarm is acknowledged by the operator. It remains red until the system no longer defines it as a dangerous target.
	Lost Radar target , indicated with crossed lines centered on the target symbol. The symbol is located at the last received position from the target.

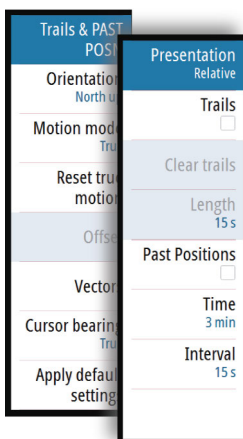

Display settings for radar targets

You select how the radar targets are displayed on the radar image in the Trails and past position sub menu.

The settings are indicated in the Indicators panel.

Trails and past position presentation mode

Trails and past position indicators can be displayed as either true or relative to own ship.

Trails and past position indicators are available in both Sea and Ground stabilization modes. See *"Selecting speed source and stabilization mode"* on page 18.

Target trails

A target trail indicates the target movement by leaving an afterglow, gradually reducing the intensity over time.

Target trails show where a target used to be, and the function is useful for quickly assessing the movement of targets relative to your own vessel.

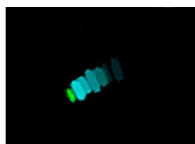

You can set the length of the trails. The length represents the time it takes for the trails to fade out.

The **Clear trails** option clears target trails from your radar panel temporarily. The trails start to build up again unless you switch the function off.

Showing a target's past positions

The Past position option is used to visualize the previous positions of a tracked target.

The time defines the length of time for which each target's past positions should be displayed on the PPI, while the interval defines interval between each past position indicator.



⚠ Warning: Trails build-up starts when exiting from the standby condition. Trails or past position length will be reached only after the selected time duration.

Possible target tracking errors

Some factors can generate tracking errors or make the radar image difficult to read, and therefore reduce target detection capability:

- Sea, rain, snow and low clouds returns
- Radar Interference
- Sidelobe echoes
- Blind sectors
- Low signal to noise ratio and signal to clutter ratio

⚠ Warning: The speed and course of a radar target are obtained by consecutive measurements of the echo position. The data is then filtered to reach the required precision. This means, that every abrupt change of speed and direction will be recognized with a certain delay to reach absolute certainty that the target is moving in a different way. The confirmation delay is about five scans and after that some additional time is needed to reach the same data precision as from before the maneuver.

Sea, rain, snow and low clouds returns

Radar echoes in sea, rain or weather clutter areas may be masked by the clutter. The effects of such errors appear as continuous big changes of the target course and speed vectors. Sometimes the symbol of a target that has been acquired at high speed can slip away from the real target position after a certain time, and this might generate the lost target alarm. These errors can be avoided or at least minimized by proper manual adjustments of sea and rain controls, or by selecting the automatic control option. For more details, see "*Adjusting the radar image*" on page 19.

Radar interference

Other radars operating in the same frequency band can generate interference. Normally this is seen on the radar screen as a series of spirals. When the interference falls on the tracked target, it can cause a deformation of the size of the echo, and consequently a small error in the target's course and speed values.

Adjustment option is available in the Advanced menu. See "*Rejecting radar interference*" on page 34.

Sidelobe echoes

Radar antennas have a radiation pattern consisting of a main lobe and several very small sidelobes. Most of the energy transmitted by the radar is radiated and received back on the main lobe, and a very small part on the sidelobes. This has no effect in case of distant or small targets, but the returns from a large target at short range (less than 3 NM) can generate, on both sides of the main echo and at the same range, arcs or series of small echoes. These effects, when they are an extension of the main echo, can cause momentary errors for the tracking, and course and speed values given by the tracking can become unstable.

The problem can usually be eliminated or strongly reduced by an accurate adjustment of the Sea control. Refer "*Sea anti-clutter*" on page 19.

Blind sectors

Funnels, masts or other obstructions (when located near the radar antenna) may cause blind or shadow sectors, where the target visibility may be completely lost or strongly reduced. Targets remaining in these sectors for long time (more than 10 antenna revolutions) will be considered lost, and the lost target alert will be triggered.

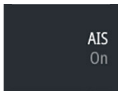

Low signal to noise ratio and signal to clutter ratio

In situations where the signal to noise or the signal to clutter ratio of the radar echoes is low (small vessels in heavy sea or rain clutter, or big vessels close to the radar horizon), target detection is poor and the tracking will not detect the target at each antenna revolution. This will cause errors in the tracking, and it can range from missed information and up to complete loss of the target when it is missed for 10 consecutive antenna revolutions.

AIS targets

If a compatible AIS receiver is connected to the radar system, any targets detected by these devices can be displayed and tracked. You can set alarms to notify you if an AIS target gets too close or if the target is lost.

The system can display up to 20 AIS targets. An alert is triggered if the number of AIS targets exceeds 95% of the maximum system limitation.

By default, all AIS targets are shown on the panel if an AIS device is connected to the system and the AIS function turned ON. You can select to filter AIS targets as described in *"AIS target filtering"* on page 28.

The AIS function is available when:

- AIS data is available through the serial line
- Gyro compass heading is available. If gyro heading is lost the AIS function is automatically switched OFF
- EPFS valid position is available

AIS target symbols

The following icons are used for AIS targets in the system:

Symbol	Description
	AIS target with heading line, SOG/COG (dotted line) and passed track.
	AIS target with heading line and SOG/COG (dotted line), and with indicated turn direction.
	Selected AIS target , indicated with a square (dotted line) around the target symbol.
	Dangerous AIS target indicated with bold line and with red color. The symbol flashes until the target alarm is acknowledged by the operator.
	Real ATON (Aids To Navigation)
	Lost AIS target , indicated with crossed lines centered on the target symbol. The symbol is located at the last received position from the target.

→ **Note:** A symbol is drawn with a dotted line if the collision avoidance cannot be calculated.

AIS target filtering

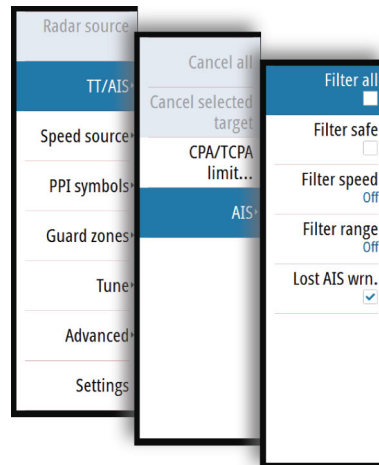

By default, all AIS targets are shown on the panel if an AIS device is connected to the system and the AIS function turned ON.

You can select to filter the icons based on AIS class, range and target speed from the AIS sub menu.

Displaying target information

By default the Target panel displays basic information about four targets. The panel displays both tracked radar targets and AIS targets, listed by distance to own vessel.

When you select a radar or an AIS target, the Target panel changes to show detailed information for the selected target. This information remains in the Target panel until the target is de-selected.

Targets	
AIS - 258382000	Danger
SOG 0.0 kn	COG 94 °T
CPA 0.56 NM	TCPA PAST
RNG 0.56 NM	BRG 145 °T
AIS - 258263500	Danger
SOG 0.1 kn	COG 279 °T
CPA 0.71 NM	TCPA PAST
RNG 0.71 NM	BRG 155 °T
TT - 10	Lost
SOG 0.0 kn	COG 90 °T
CPA 0.22 NM	TCPA 0:04:07
RNG 58.0 m	BRG 238 °T
TT - 8	Lost
SOG 0.0 kn	COG 90 °T
CPA 0.22 NM	TCPA 0:04:07
RNG 108 m	BRG 38 °T

Target panel - no targets selected

AIS - GUBBEN		Safe
SOG	0.0	kn
COG	0	°T
CPA	-	NM
TCPA	-	
RNG	0.29	NM
BRG	349	°T
ROT	-	°/sec
HDG	-	°T
POSN		
N 58°27.261'		
E 5°58.893'		
POSN Quality		
High (10m)		
Nav Status		
Unknown		

Target panel - AIS target selected

The Vessels dialog displays a list of all tracked targets. The dialog is activated from the Own ship settings menu.

This dialog lists targets by distance to own vessel, but allows for sorting the targets based on target name.

Settings

- System
- Radar
- Position
- Alerts
- Units
- Network
- Own ship
- Simulator

Setup...

MMSI 0

AIS/TT data...

Vessels

Name	Distance	CPA	Type
	Bearing	TCPA	Status
258347500	-	-	AIS lost
277380000	0.86 NM 170 °T	-	AIS safe
AGATHE	137 m 160 °T	-	AIS
FFS ACHILLES	0.55 NM 140 °T	-	AIS safe
FISKEBOEN	0.83 NM 163 °T	-	AIS safe
LOS 117	0.71 NM 155 °T	-	AIS safe
MERSEY	0.57 NM 109 °T	-	AIS safe
MISIMA	0.44 NM 187 °T	-	AIS safe

Sort Name View All Close

7

Navigation tools

Guard zones

The Guard zone function is used to warn the user about objects inside a specified zone ahead or around your vessel.

You can define two guard zones with individual settings.

When a guard zone is activated the following happens:

- Any radar echo and AIS target received near the same position for 3 consecutive scans are automatically acquired
- The target symbol change to indicate a dangerous target
- An alert text is displayed in the Alert panel

The alert indications remains as long as the target is within the guard zone.

You turn the guard zones on/off and manage the guard zone settings from the Guard zones sub menu.

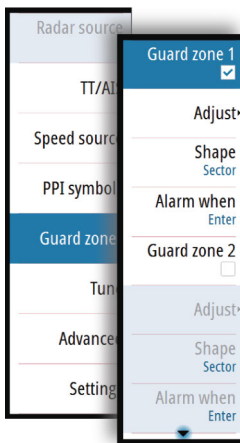

Defining a guard zone

1. Turn on the guard zone you want to define
2. Select the shape for the zone
 - The adjustment options depends on the guard zone shape
3. Select **Adjust** to define the setting for the guard zone:
 - **A**: Bearing, relative to vessel heading
 - **B**: Depth
 - **C**: Range, relative to vessel center
 - **D**: Width
4. Return to previous menu level by pressing the **EXIT** key or by selecting the **Finish adjusting** option in the menu.

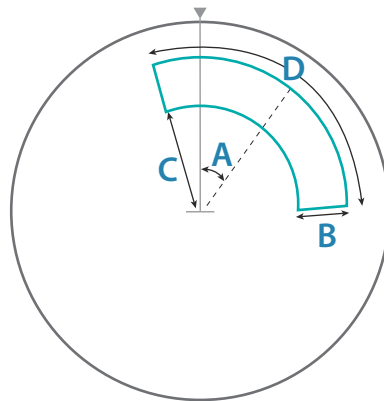

Shape: Sector

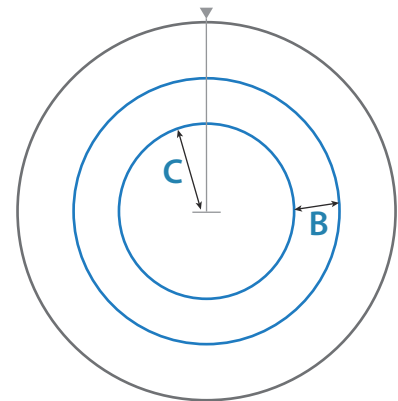

Shape: Circle

EBL/VRM markers

The EBL/VRM markers are a basic tool for collision avoidance. They are used to mark any fixed or moving radar target, and to measure distances between two objects.

The EBL/VRM markers are by default positioned at the center of the vessel. It is, however, possible to offset the reference point to any selected position on the radar image to measure the distance between two objects on the PPI, or to fix the marker to a target.

Two different EBL/VRMs can be placed on the radar image. They are identified as dashed rings/lines with different colors to be able to discriminate them from each other and from the fixed range rings:

- EBL/VRM1 is cyan
- EBL/VRM2 is blue

The EBL presentation can be defined with true or relative presentation:

- True motion: the reference is geographic (e.g. a coastal line or current own vessel position)
- Relative motion: the EBL follows a moving reference (own vessel or a moving target)

The markers' line width indicates whether the marker is in edit mode (bold lines) or at a fixed position (thin lines).

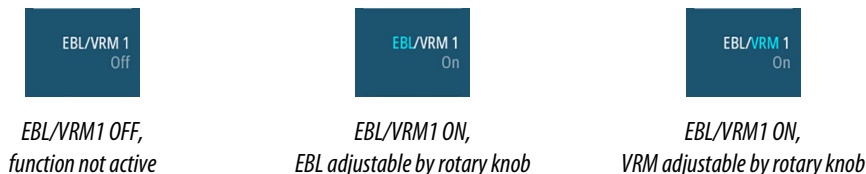

The EBL/VRM pop-up

You display the EBL/VRM pop-up by pressing the **EBL/VRM** softkey twice, or by re-pressing the softkey when the function is active.

The content of the pop-up depends on status of the active EBL/VRM. The example shows the pop-up when active EBL/VRM is offset.

The adjustable parameter is indicated with blue text in the softkey.

From the pop-up you can:

- switch between active EBL/VRM 1 and EBL/VRM 2 marker
- turn on and off displaying of the active marker
- switch between adjusting EBL and VRM for the active marker. You can also switch between adjustable parameter by pressing the rotary knob
- set offset for active marker
- reset an offset marker to vessel position

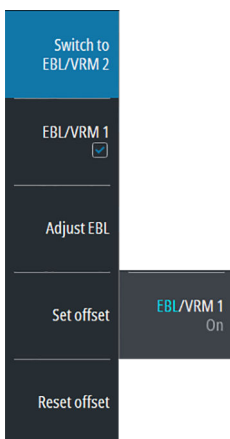

Turning the EBL/VRM markers on and off

Both EBL/VRM markers are by system startup turned off.

- Turn ON the selected EBL/VRM by pressing the EBL/VRM softkey once
- Switch between EBL/VRM 1 and EBL/VRM 2 in the function's pop-up
- Turn OFF the selected EBL/VRM by pressing the **EXIT** key. Re-press the **EXIT** key to turn off the second marker if this is on.
- Leave the EBL/VRM function with the marker ON by pressing one of the other softkeys

You can also turn the EBL/VRM marker on and off from the function's pop-up.

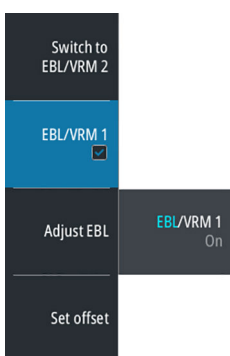

Adjusting the EBL/VRM marker

The markers' line width indicates whether the marker is in edit mode or at a fixed position. When in edit mode the adjustable parameter is bold.

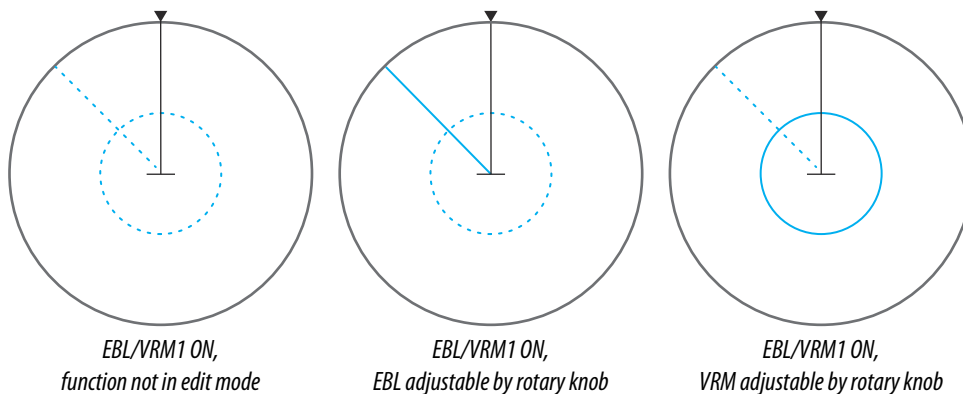

When an EBL/VRM marker is in edit mode, the following options are available for adjusting the marker:

- use the arrow keys to move the EBL/VRM intersection
- turn the rotary knob to adjust the adjustable parameter (bold line and blue text in softkey)

- press the rotary knob to switch between adjusting EBL and VRM

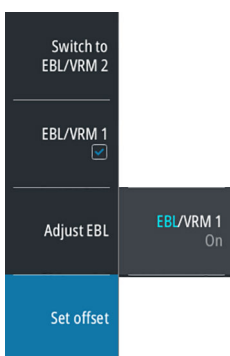

Offsetting the EBL/VRM marker

1. Press the EBL/VRM softkey twice to display the pop-up
2. Select the **Set offset** option
 - The pop-up closes, and the cursor is positioned in the EBL/VRM center
3. Use the arrow keys to move the EBL/VRM center, then select one of the following options:
 - press the **ENT** key to fix the marker to the selected position, then use the arrow keys to move the EBL/VRM intersection
 - turn the rotary knob to adjust the EBL
 - press the rotary knob to toggle between EBL and VRM, then turn the rotary knob or use the arrow keys to adjust the item that is editable

You remove the EBL/VRM marker from the radar image by pressing the **EXIT** key.

Measuring range and bearing

Different options are available for measuring the position, speed, course, distance and bearing of radar echoes.

- Cursor position
- Range rings and bearing scale
- EBL (Electronic Bearing Lines) and VRM (Variable Range Markers)

It is important to minimize the range to obtain the best precision for the measurement. In most cases you can use a higher range if you position the PPI in one of the off-center modes. Refer "*Offsetting the PPI center*" on page 22.

→ **Note:** Every measurement made with cursor or EBL/VRM is always referred to the Consistent Common Reference Point (CCRP).

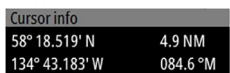

Using the cursor

When you position the cursor over an echo, the cursor information area will show range and bearing from the vessel to the cursor position.

This measuring option gives a fast and precise measurement of distance to a target.

Range rings and bearing scale

Range rings and bearing scale is used to measure distance when a fast measurement is required. This measuring option gives only an approximate distance and speed of a target.

The range scale (**A**) and the distance between two adjacent range rings (**B**) are shown in the System Information are on the radar image.

The range scales, the related distance between the range rings and number of rings are:

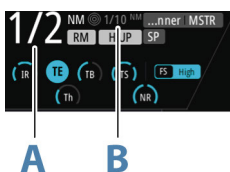

Range (NM)	Distance between the range rings (NM)	Number of range rings
1/8	1/40	5
1/4	1/20	5
1/2	1/10	5
3/4	1/4	3
1.5	1/4	6
3	1/2	6
6	1	6
12	2	6
24	4	6
36	6	6
48	8	6

Range (NM)	Distance between the range rings (NM)	Number of range rings
64	16	4
72	12	6



Measuring by using EBL/VRM markers

The Electronic Bearing Line (EBL) and Variable Range Marker (VRM) allows quick measurements of range and bearing from own vessel to a target, or between two targets on the PPI. Bearing and range are shown in the Markers panel (A).

Measuring distance from own vessel

1. Press the EBL/VRM softkey to turn the selected EBL/VRM marker on
2. Re-press the EBL/VRM softkey to display the pop-up if you need to reposition the marker to vessel position (if the center of the selected EBL/VRM is offset)
3. Use the arrow keys or turn the rotary knob to position the EBL/VRM on the second measuring point

Measuring distance between two objects

1. Press the EBL/VRM softkey twice
 - The selected EBL/VRM marker is turned on and the pop-up displayed
2. Select the **Set offset** option
3. Use the arrow keys to reposition the EBL/VRM marker's center on the object from where you want to measure the distance
4. Press the **ENT** key to confirm the position
 - The cursor will automatically be moved from the marker's center to the EBL/VRM intersection
5. Use the arrow keys or turn the rotary knob to move the EBL/VRM to the second measuring point
 - Range and bearing from the EBL/VRM marker's center to cursor position is now displayed in the Markers panel

You can reset the EBL/VRM marker's center to vessel position by selecting the **Reset offset** option in the EBL/VRM pop-up.

8

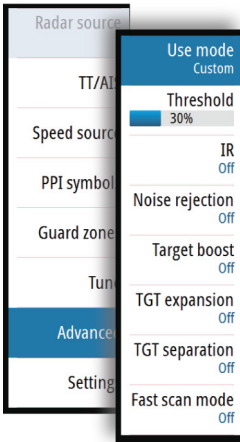

Advanced radar options

Use modes

→ **Note:** Radar User modes are only available for Halo radar antennas.

Use modes are available with preset control settings for different environments. The following modes are available:

- **Custom** - In this mode all radar controls can be adjusted and will be retained after a mode change or radar power cycle. Radar defaults are set for general purpose use.
- **Harbor** - In this mode the radar settings are optimized for areas such as busy waterways and large man-made structures where good target discrimination and rapid image updates are needed.
- **Offshore** - In this mode the radar settings are optimized for offshore sea conditions and making isolated targets larger and easy to see.
- **Weather** - In this mode the radar settings are optimized for best detection and presentation of rain clutter. Image update rate is slowed and color depth is increased.
- **Bird** - In this mode the radar settings are optimized for best detection of birds. The radar is set up for maximum sensitivity. This mode is not recommended for use in congested harbor environments.

Not all controls are adjustable in each mode. The following table shows preset controls and adjustability for each control.

Mode:	Custom	Harbor	Offshore	Weather	Bird
Control:					
Range	Full *	Full *	Full *	Full *	Up to 24nm
Gain	Adjustable	Adjustable	Adjustable	Adjustable	Adjustable
Sea	Adjustable	Adjustable	Adjustable	Adjustable	Adjustable
Rain	Adjustable	Adjustable	Adjustable	Adjustable	Adjustable
Noise rejection	Adjustable	Medium	High	Medium	High
Threshold	Adjustable	30%	30%	0%	0%
Target Expansion	Adjustable	Low	Medium	Off	Off
Interference Reject	Adjustable	Adjustable	Adjustable	Adjustable	Adjustable
Target Separation	Adjustable	Medium	Off	Off	Off
Fast scan	Adjustable	High	High	Off	Off

* Maximum range is dependent on antenna length: 3' = 48 nm, 4' = 64 nm and 6' = 72 nm.

Radar threshold

The threshold sets required signal strength for the lowest radar signals. Radar returns below this limit are filtered and are not displayed.

Default value: 30%.

Rejecting radar interference

Interference could be caused by radar signals from other radar units operating in the same frequency band.

A high setting reduces the interference from other radars.

In order not to miss weak targets, the interference rejection should be set to low when no interference exists.

Noise rejection

The Noise Rejection control sets the amount of noise filtering applied by the radar. Target sensitivity is increased at longer ranges when this control is set to Low or High, but does cause some loss of target discrimination.

Target boost

The target boost control increases pulse length or reduces radar bandwidth to make targets appear larger in range and increase radar sensitivity.

Target expansion

Target expansion increases the length of targets in range, making them easier to see.

Target separation

The **Target separation** control allows you to control the target discrimination of the radar (separation between objects is more prominent).

Fast scan

Sets the speed of the radar antenna rotation. This option gives faster target updates.

→ **Note:** Maximum speed may not be achieved depending on the radar Settings, Mode, and Range selected. The radar will only rotate as fast as the current control settings allow.

9

Installation

Box contents

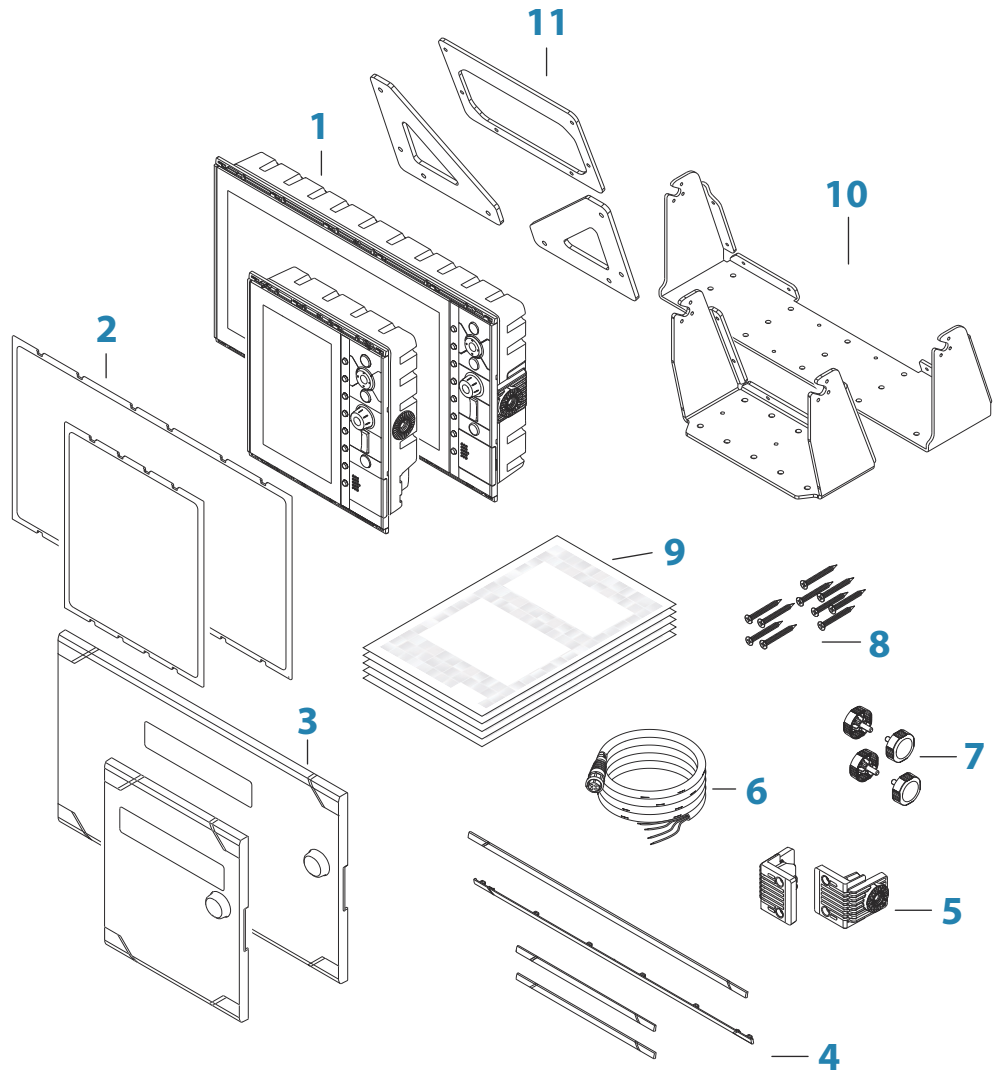

- 1 Control unit
- 2 Panel mounting gasket
- 3 Sun cover
- 4 Bezels
- 5 Gimbal inserts (R3016 only)
- 6 Power cable
- 7 Knobs
- 8 Fixing screws
- 9 Documentation pack
- 10 U-brackets
- 11 U-bracket straps (one for R2009, two for R3016)

Mounting location

Choose the mounting locations carefully before you drill or cut. The unit should be mounted so that the operator can easily use the controls and clearly see the screen. Be sure to leave a direct path for all of the cables. The unit has a high-contrast screen, and is viewable in direct

sunlight, but for best results install the unit out of direct sunlight. The chosen location should have minimal glare from windows or bright objects.

Ensure that any holes cut are in a safe position and will not weaken the boat's structure. If in doubt, consult a qualified boat builder, or marine electronics installer.

Before cutting a hole in a panel, make sure that there are no hidden electrical wires or other parts behind the panel.

Check that it is possible to route cables to the intended mounting location.

Leave sufficient clearance to connect all relevant cables.

Do not mount any part where it can be used as a hand hold, where it might be submerged, or where it will interfere with the operation, launching, or retrieving of the boat.

Choose an area where the unit will not be subjected to excessive vibration, or heat.

Good ventilation is required.

⚠ Warning: Inadequate ventilation may cause the unit to overheat. The unit is designed to operate in temperatures from -15°C to $+55^{\circ}\text{C}$ ($+5^{\circ}\text{F}$ to $+131^{\circ}\text{F}$).

⚠ Warning: When installing, ensure appropriate safety equipment is used. For example, ear muffs, protective glasses, gloves and a dust mask. Power tools may exceed safe noise levels, and can cast off dangerous projectiles. The dust from many materials commonly used in boat construction may cause irritation or damage to eyes, skin, and lungs.

Viewing angle

The viewing angle influences the visibility of the monitor. The recommended viewing angles relative to perpendicular are shown in the illustrations below.

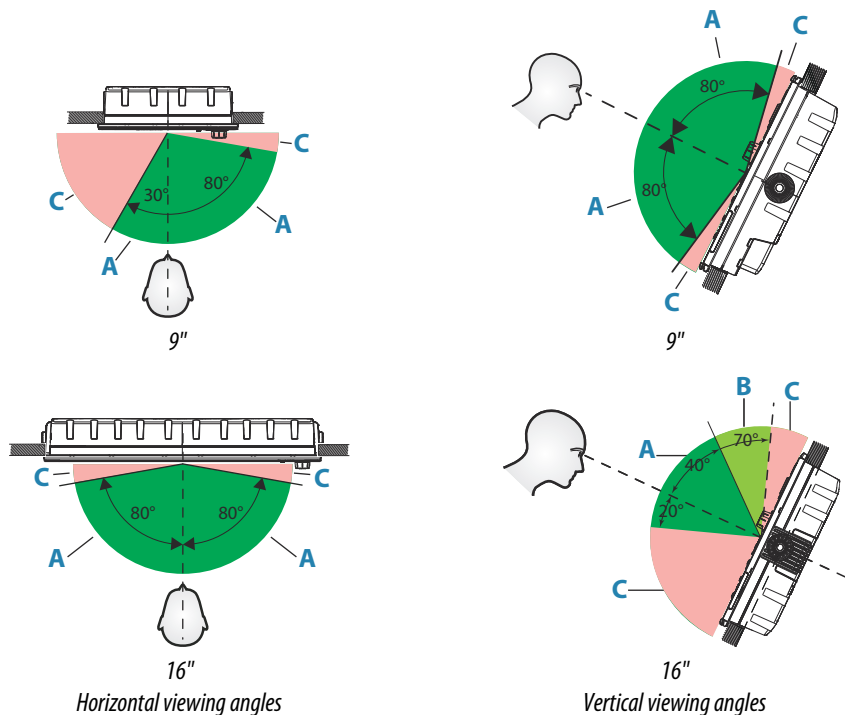

- A** Optimum viewing angle
- B** Good viewing angle
- C** Poor viewing angle or obstructed view

→ **Note:** Installations requiring better left hand visibility on the 9" unit can optimize the display for viewing from the left. Refer to "View from left" on page 52.

U-bracket mounting

→ **Note:** Illustrations show the 16" unit. The bracket strap for the 9" unit looks different, but the same procedure is used for fixing it to the bracket.

1. Place the bracket in the desired mounting location. Ensure that the chosen location has enough height to accommodate the unit fitted in the bracket, and allows tilting of the unit. Also adequate space is required on both sides to allow tightening and loosening of the knobs.
2. Mark the screw locations using the bracket as a template, and drill pilot holes. Use fasteners suited to the mounting surface material. If the material is too thin for self-tappers, reinforce it, or mount the bracket with machine screws and large washers. Use only 304 or 316 stainless steel fasteners.
3. Screw down the bracket.
4. (16" units only) Using the screws provided in the gimbal kit, fasten the gimbals to the unit.
5. Mount the unit to the bracket using the knobs. Hand tighten only. The ratchet teeth in the bracket and display case ensure a positive grip and prevent the unit changing from the desired angle.
6. Fix the bracket straps.

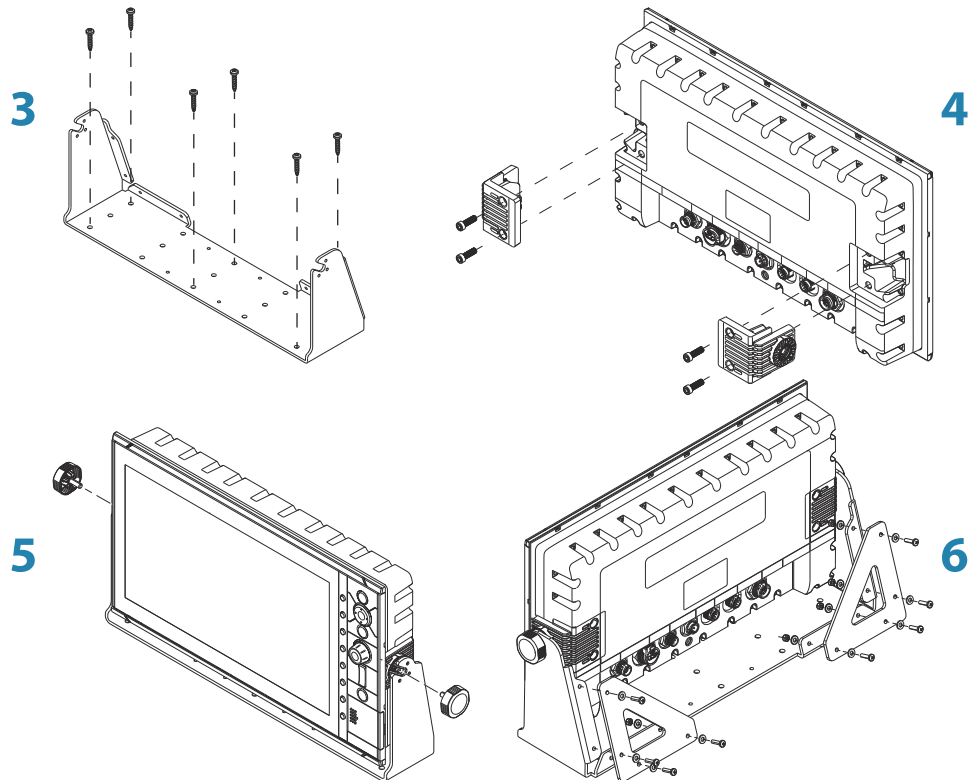

Panel mounting

The screws and gasket used for panel mounting are included in the box. For mounting instructions, refer to the Panel mounting template.

10

Wiring

Guidelines

Don't do this:	Do this:
Don't make sharp bends in the cables.	Do make drip and service loops.
Don't run cables in a way that allows water to flow down into the connectors.	Do cable-tie all cables to keep them secure.
Don't route the data cables adjacent to radar, transmitter, or large/high current carrying cables or high frequency signal cables.	
	Do leave room adjacent to connectors to ease plugging and unplugging of cables.

⚠ Warning: Before starting the installation, be sure to turn electrical power off. If power is left on or turned on during the installation, fire, electrical shock, or other serious injury may occur. Be sure that the voltage of the power supply is compatible with the unit.

⚠ Warning: The positive supply wire (red) should always be connected to (+) DC with the supplied fuse or a circuit breaker (closest available to fuse rating).

Rear connections

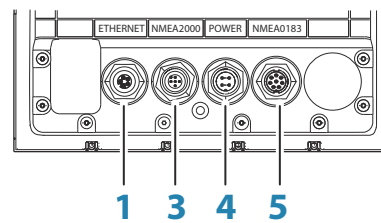

R2009 Rear connections

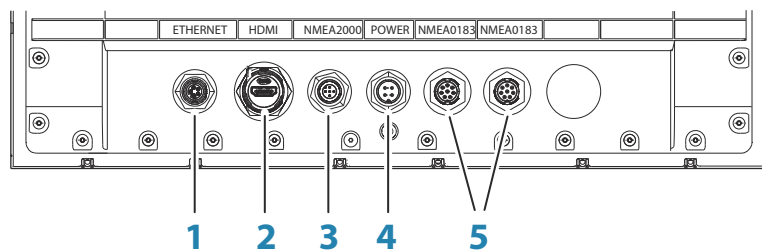

R3016 Rear connections

- 1 Ethernet, 5-pin
- 2 HDMI (available on R3016 only)
- 3 NMEA 2000, 5-pin
- 4 Power, 4-pin
- 5 NMEA 0183, 8-pin

Ethernet connector

The unit is equipped with an Ethernet port, which allows connecting the unit to your network using the 5 pin Ethernet connector.

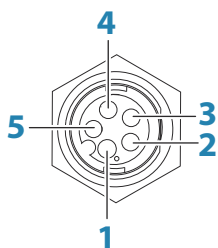

- 1 Transmit positive TX+, blue/white wire
- 2 Transmit negative TX-, blue wire
- 3 Receive positive RX+, orange/white wire
- 4 Receive negative RX-, orange wire
- 5 Shield

Power connection

The supplied power cable has four cores used for:

- Power into the system (Red and Black wires).
- Controlling power state of the unit (Yellow wire).
- Connecting to an external alarm (Blue wire).

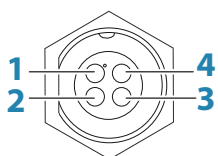
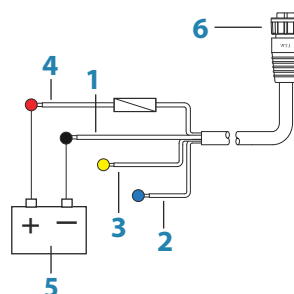

- 1 12/24 V DC negative supply, black wire
- 2 External Alarm, blue wire
- 3 Power control (R2009) or return for the blue wire isolated signal (R3016), yellow wire
- 4 12/24 V DC positive supply (red wire), shown with fuse holder fitted
- 5 12/24 V DC power supply
- 6 Power cable connector to unit, 4-pin

Power Control connection

The yellow Power Control wire in the power cable is an input that will turn on the unit when power is applied.

The following power control options are available for the R2009 Control unit:

- Power controlled by the **STANDBY/BRILL** key: Yellow wire not connected
- Power controlled by a Power Master unit: Yellow wires on the R2009 and on the Power Master unit are connected (power control bus).

→ **Note:** If the R2009 is set to Power Slave, the unit cannot be powered down using its own **POWER/BRILL** key. Pressing and holding this key will set the unit to standby. Refer to "Power Control" on page 45.

Power Control unconnected

Device will turn on and off when the power button on the front of the unit is pressed. Leave the yellow Power Control wire disconnected and tape or heat-shrink the end to prevent shorting.

Power Control to supply positive (auto on)

Device will turn on immediately when power is applied. Common the yellow wire with the red wire after the fuse.

→ **Note:** The unit cannot be powered down by power button, but can be put in to standby mode. (The screen backlight turns off.)

External alarm

The external alarm can be a small piezo buzzer connected directly, or a horn siren connected through a relay.

Alarms are configured globally in the system. That is, they can be configured on any one networked multifunction device or instrument, and be seen, heard, and acknowledged from all devices. Individual devices can also be configured to not sound their internal buzzer, but still display the alarm information. For information about configuring alarms, refer to the Alarms section in the Operator Manual.

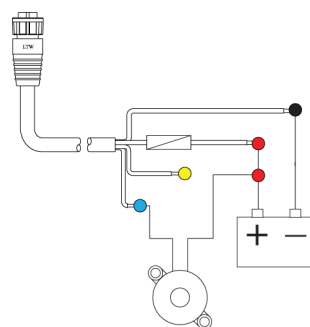

For sirens that draw more than 1 Amp, use a relay.

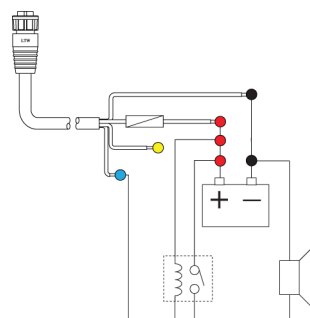

NMEA 2000 backbone

NMEA 2000 Device connection

The unit is equipped with an NMEA 2000 data port, which allows the receiving and sharing of a multitude of data from various sources.

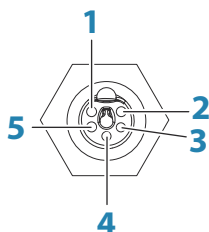

- 1 Shield, bare wire
- 2 NET-S (+12 V DC), red wire
- 3 NET-C (-12 V DC), black wire
- 4 NET-H, white wire
- 5 NET-L, blue wire

Planning and installing a network backbone

The backbone needs to run between the locations of all products to be installed - typically in a bow to stern layout - and be no further than 6 m from a device to be connected.

Choose from the following components to make up the backbone:

- Micro-C cables: 0.6 m (2 ft), 1.8 m (6 ft), 4.5 m (15 ft), and 7.6 m (25 ft) cables.
- T-connector or 4-way connector. Used to connect a drop cable to the backbone.
- Micro-C power cable. Connect to the backbone at a position that is central to the network load using a T-connector or 4-way connector.

Power the network

The network requires its own 12 V DC power supply protected by a 3 amp fuse or breaker.

Connect power at any location in the backbone for smaller systems.

For larger systems introduce power at central point in the backbone to “balance” the voltage drop of the network.

- **Note:** If joining to an existing NMEA 2000 network that already has its own power supply, do not make another power connection elsewhere in the network, and ensure the existing network is not powered by 24 V DC.
- **Note:** Do not connect the NMEA 2000 power cable to the same terminals as the engine start batteries, autopilot computer, bow thruster or other high current devices.

The following drawing demonstrates a typical small network. The backbone is made up of directly interconnected T-connectors.

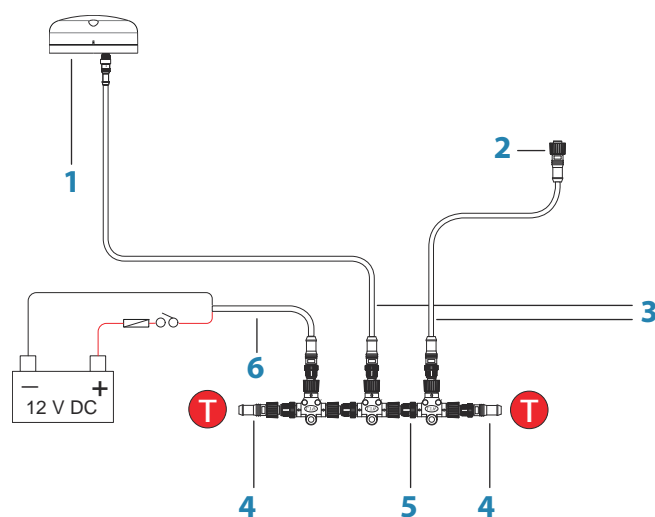

- 1 NMEA 2000 device
- 2 Connector to unit
- 3 Drop-cable, should not exceed 6 m (20 ft)
- 4 Terminators
- 5 Backbone
- 6 Power cable

NMEA 0183 device connection

The unit has an NMEA 0183 serial port, providing both an input and an output. The port uses the NMEA 0183 (serial balanced) standard, and can be configured in the software for different baud rates up to 38,400 baud.

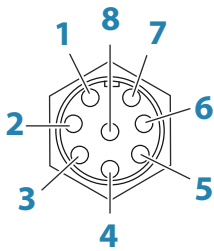

- 1 Listener 2B TX_B, brown/white wire
- 2 Listener 2A TX_A, brown wire
- 3 Talker 2B RX_B, green/white wire
- 4 Talker 2A RX_A, green wire
- 5 Talker 1B RX_B, orange/white wire
- 6 Talker 1A TX_A, orange wire
- 7 Listener 1A RX_A, blue/white wire
- 8 Listener 1B RX_B, blue wire

Talkers and Listeners

Do not connect multiple devices outputting data (Talkers) on to any serial input (RX) of the unit. The RS422 protocol is not intended for this type of connection, and data will be corrupted if more than one device transmits simultaneously. The output (TX) however may drive multiple receivers (Listeners). The number of receivers is finite, and depends on the receiving hardware. Typically three devices is possible.

Connect an external monitor

The R3016 incorporates HDMI technology and has a HDMI output which can be connected to an external monitor to replicate video at a remote location. Video is at a resolution of 1366 x 768, a connected monitor should support same resolution or be able to scale.

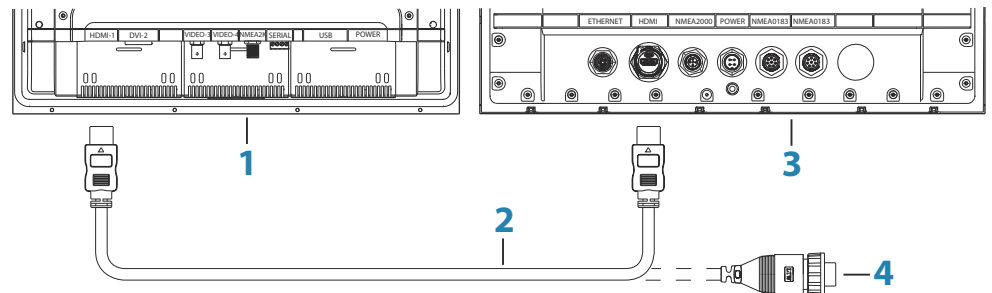

- 1 MO series monitor
- 2 HDMI cable
- 3 R3016
- 4 HDMI cable - waterproof connector (use in exposed installations)

→ **Note:** While the HDMI standard does not state maximum cable length, signal may be compromised on long runs. Only use Navico or other high quality HDMI certified cables. 3rd party cables should be tested before installation. On runs over 10m it may be required to add an HDMI amplifier or use HDMI-CAT6 adaptors.

→ **Note:** Some HDMI TV displays may apply over-scan, which will in effect crop the image possibly causing loss of important content. Check the display manual for an option to disable over-scan or adjust scaling

11

Software setup

Prior to use, the radar system requires a number of settings be configured in order for the system to perform as expected.

Access to the required dialogs for commissioning are found in the **Settings** dialog, accessed from the main menu.

The settings dialogs consist of numerous parameters that will seldom require adjustment beyond initial setup. All settings are stored in non-volatile memory. Most are intended to be configured by the technician commissioning the system, by the operator at first use, or by a technician after servicing or replacement of system parts.

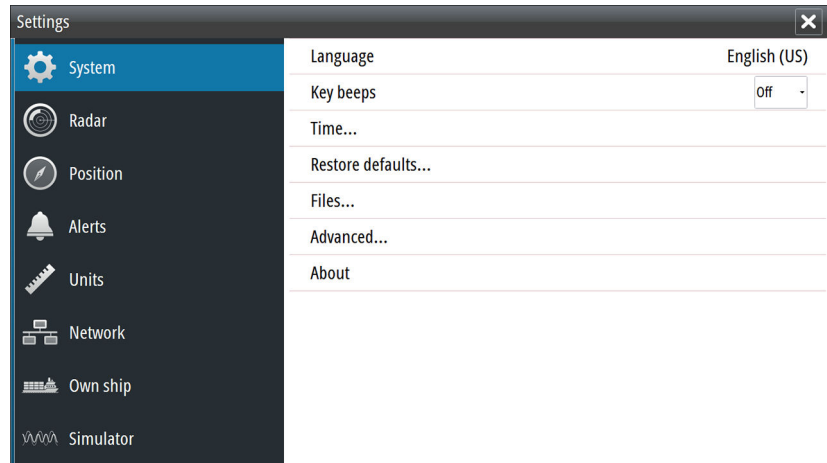

The following areas must all be addressed during commissioning, and should be stepped through one at a time. Refer to the detailed sections for further information.

- 1 General system settings. Refer "*System settings*" on page 44
- 2 Setting up external sensors. Refer "*Network settings*" on page 45
- 3 Radar Settings. Refer "*Radar settings*" on page 48
- 4 Own vessel characteristics. Refer "*Own ship*" on page 52

System settings

Use the system settings dialog to set basic settings as described below. Some settings can require a reboot of the system.

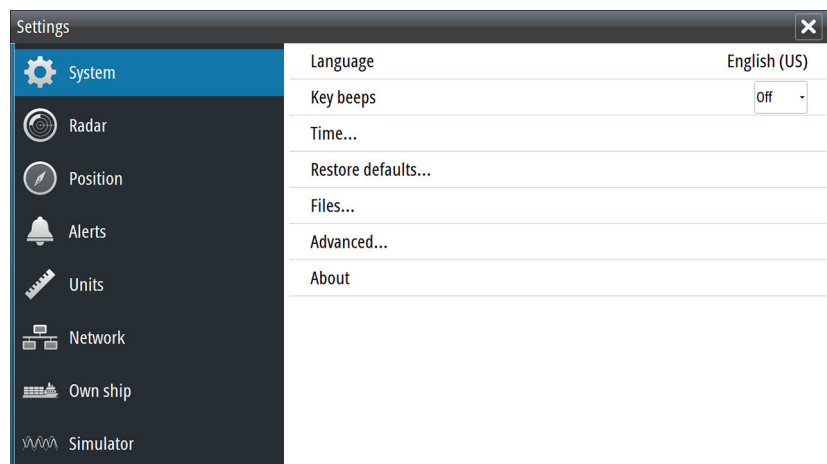

Language

Controls the language used on this unit for panels, menus, and dialogs. Changing the language causes the unit to restart.

Key beeps

Controls the loudness of the beep sound when a key is pressed.

Default setting: Loud

Time

Controls the local time zone offset, and the format of the time and date.

Restore defaults

Allows you to select which settings are to be restored to their original factory settings.

Power Control

→ **Note:** This option is available for R2009 Control units only.

Used for defining the R2009 Control unit as a power slave.

This setting is only applicable if the yellow wire is connected to ignition or to a stand-alone switch that applies 12 V/24 V.

→ **Note:** You cannot use the **STANDBY/BRILLIANCE** key to power down a unit that is set to power slave. The unit is powered off when the power master is powered down, or when the system power is removed.

Files

File management system for Files and backing up system settings.

Advanced

Shows a panel with more advanced settings. Used for setting how your system displays various user interface information. In addition, controls which features are shown in the interface.

About

Displays copyright information, software version, and technical information for this unit.

Network settings

The unit has Ethernet, NMEA 0183 and NMEA 2000 port connections on the back allowing you to connect the unit to your network. Use the Network settings dialog to setup networks and connect to network devices.

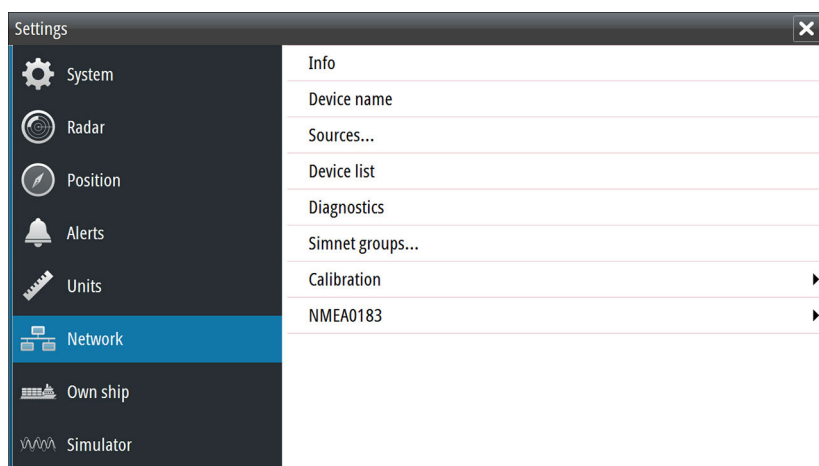

Info

Displays the Ethernet connection status, the unit's IP and MAC addresses.

Device name

Assigning a name is useful in systems using more than one device of the same type and size. When viewing data sources or the device list, the assigned name will append the default product name + virtual device function for easy identification.

Data source selection

Data sources provide live data to the system.

The data may originate from modules internal to the unit (for example internal GPS or sonar), or external modules connected to the NMEA 2000 or via NMEA 0183 if available on the unit.

When a device is connected to more than one source providing the same data, the user can choose the preferred source. Before commencing with source selection make sure all external devices and the NMEA 2000 backbone are connected and are turned on.

Auto select data sources

The Auto select option looks for all sources connected to the unit. If more than one source is available for each data type, selection is made from an internal priority list. This option is suitable for the majority of installations.

→ **Note:** Auto data source selection may already have been selected at first time startup. However, it should be redone if any new devices have been added to the network since.

Advanced data source selection

The advanced option allows for you to manually select or unselect data sources. Manual selection is generally only required where there is more than one source for the same data, and the 'Auto select' selected source is not the one desired.

Device list

The Device list shows the devices that provide data. This may include a module inside the unit, or any external NMEA 2000 device.

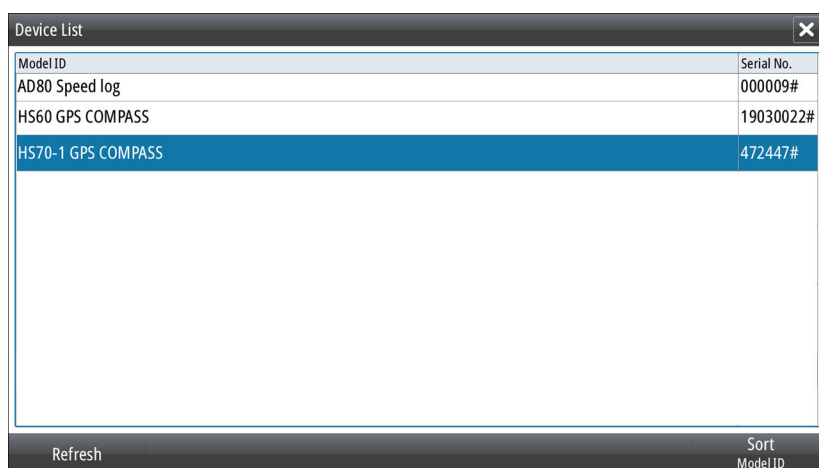

Model ID	Serial No.
AD80 Speed log	000009#
HS60 GPS COMPASS	19030022#
HS70-1 GPS COMPASS	472447#

Selecting a device in this list will bring up additional details and actions:

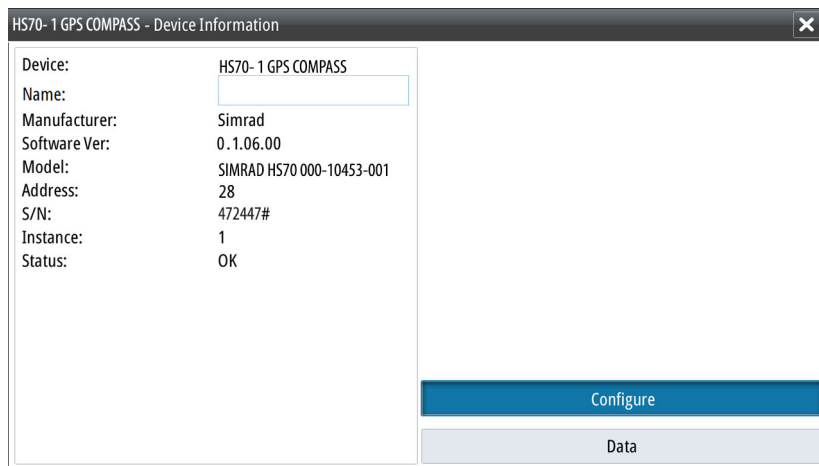

All devices allow allocation of an instance number in the configure option. Set unique instance numbers on any identical devices on the network to allow for the unit to distinguish between them. The data option shows all data being output by the device. Some devices will show additional options specific to the device.

→ **Note:** Setting the instance number on a 3rd party product is typically not possible.

Diagnostics

The NMEA 2000 tab on the diagnostics page can provide information useful for identifying an issue with the network.

→ **Note:** The following information may not always indicate an issue that can be simply resolved with minor adjustment to network layout or connected devices and their activity on the network. However, Rx and Tx errors are most likely indicating issues with the physical network, which may be resolved by correcting termination, reducing backbone or drop lengths, or reducing the number of network nodes (devices).

Bus state

Simply indicates whether the bus is powered, but not necessarily connected to any data sources. However, if bus shows as 'off', but power is present along with an increasing error count, it is possible that termination or cable topology is incorrect.

Rx Overflows

The unit received too many messages for its buffer before the application could read them.

Rx Overruns

The unit contained too many messages for its buffer before the driver could read them.

Rx/Tx Errors

These two numbers increase when there are error messages, and decrease when messages are received successfully. These (unlike the other values) are not a cumulative count. Under normal operation these should be at 0. Values around 96 upwards indicate a heavily error prone network. If these numbers go too high for a given device, it will automatically drop off the bus.

Rx/Tx Messages

Shows actual traffic in and out of device.

Bus Load

A high value here indicates network is near full capacity. Some devices automatically adjust rate of transmission, if network traffic is heavy.

Fast Packet Errors

Cumulative counter of any fast packet error. This could be a missed frame, or a frame out of sequence etc. NMEA 2000 PGNs are made of up to 32 frames. The entire message will be discarded when a frame is missed.

→ **Note:** Rx and Tx Errors often indicate an issue with the physical network, which may be resolved by correcting termination, reducing backbone or drop lengths, or reducing the number of network nodes (devices).

Reset counters

Resets all counters in the NMEA 2000 tab of the Diagnostics dialog to zero. The counters start recounting immediately.

SimNet Groups

The SimNet Group function is used to control parameter settings, either globally or in groups of units. The function is used on larger vessels where several SimNet units are connected to the network. By assigning several units to the same group, a parameter update on one unit will have the same effect on the rest of the group members.

Calibration

An offset (positive or negative) can be applied to correct inaccuracies in boat speed, sea temp, air temp, barometric pressure, and depth sourced from NMEA 2000 devices.

NMEA 0183 setup

The NMEA 0183 port must be set to suit the speed of connected devices, and can be configured to output only the sentences required by listening devices.

Serial ports

Specify the baud rate for port for the devices connected to the NMEA 0183. The baud rate should be set to correspond with devices connected to the NMEA 0183 input and output. The input and output (Tx, Rx) use the same baud rate setting.

Serial Output

Selection determines whether the data is output via Tx lines, and will enable editing of the output sentences list.

Serial Output Sentences

This list allows control over which sentences need to be transmitted to other devices from the NMEA 0183 port. Due to the limited bandwidth of NMEA 0183 it is desirable to only enable the data that is required. The less sentences that are selected, the higher the output rate of the enabled sentences.

Commonly used sentences are enabled by default.

Radar settings



Expanded PPI

With this option selected the radar video outside the bearing scale is also visible.

Radar installation dialog

The content of the radar Installation dialog depends on the radar antenna connected to the system as per the table below.

All options are described in the next sections.

Option	10 kW	25 kW	3G	4G	Halo
Radar source	x	x	x	x	x
Radar status	x	x	x	x	x
Antenna setup	x	x	x	x	x
Adjust range offset	x	x			
Adjust bearing alignment	x	x	x	x	x
Sector blanking					x
Sidelobe suppression			x	x	x
Tune	x	x			
Adjust local interference rejection			x	x	
Adjust open array park angle					x
Halo light					x
Reset radar to factory defaults	x	x	x	x	x

→ **Note:** Other installation options are available for the R3016 12U/6X systems. Refer to the R3016 12U/6X Commissioning and Maintenance manual for details.

Radar source

More than one antenna can be connected to the radar control unit.

Use this option to select the antenna that is to be configured.

Radar status

Primarily for information and to assist with fault finding.

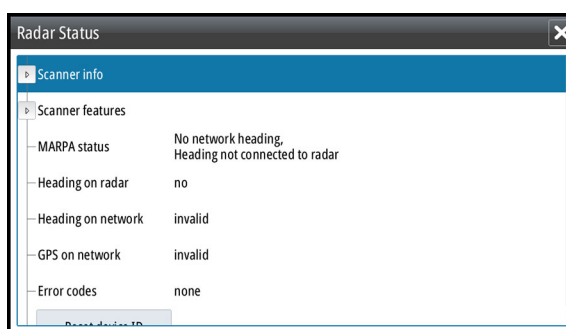

Antenna setup

This function is used for setting position and height of radar transceiver on the vessel.

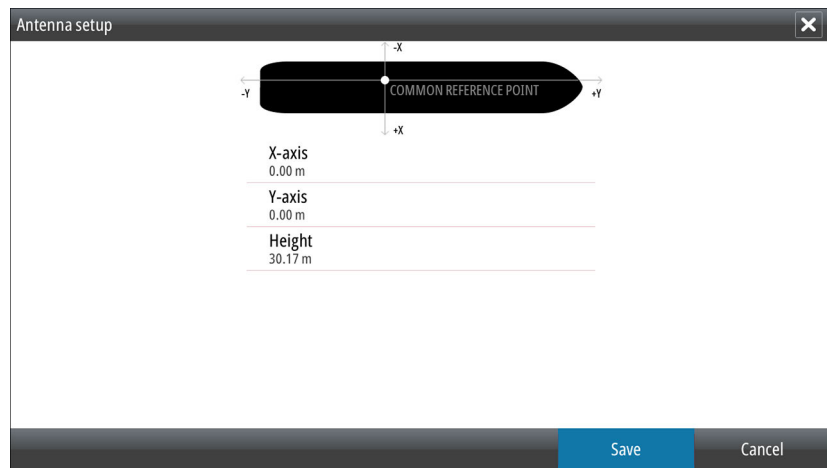

The approximate position of the transceiver on the vessel must be set in order to correctly position the vessel outline when viewing close range settings.

The antenna height is the height of the antenna above the water line, when vessel is carrying a typical load. It is very important to set the antenna height correctly as this will affect the sea clutter function. Do not set the height to 0.

Adjusting range offset

The radar sweep should commence at your vessel (a radar range of zero). You may need to adjust the radar range offset to achieve this. If this is set incorrectly, a large dark circle in the center of the sweep might occur. You might notice straight objects such as straight sea walls or piers having curves or an indentation. Objects close to your vessel may appear “pulled in” or “pushed out”.

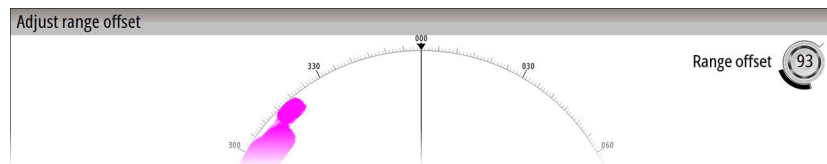

Adjust the range offset as below when the vessel is about 45 to 90 m (50 to 100 yards) from a straight-walled jetty or similar feature that produces a straight line echo on the display.

- Point the boat towards the jetty
- Adjust the gain setting until a reasonably good image of the jetty echo is displayed

With the Range offset dialog open:

- Turn the rotary knob to adjust the range offset to make the jetty echo appear as a straight line on the display
- Press the **ENT** key to save the settings

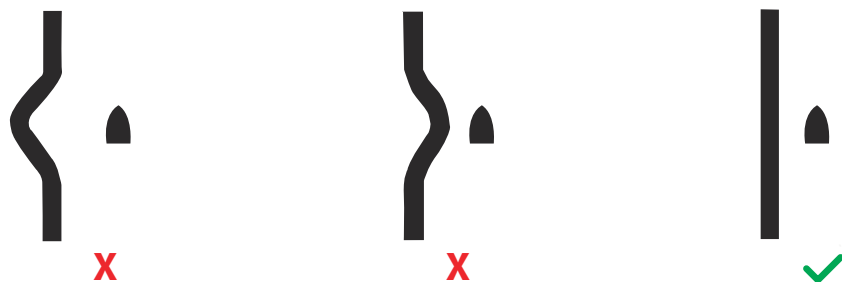

Adjust bearing alignment

This is to align the heading marker on the screen with the centre line of the vessel. This setting compensates for any slight misalignment of the up-mast transceiver during installation. Misalignment that is not corrected for will compromise target tracking and can result in dangerous misinterpretation of potential navigation hazards.

Point the vessel towards a stationary isolated object. Then with the Bearing alignment dialog open:

- Press the rotary knob to switch focus between coarse and fine bearing alignment
- Turn the rotary knob to adjust the bearing alignment so that the heading line touches the end of the selected stationary object
- Press the **ENT** key to save the settings and close the Bearing alignment dialog

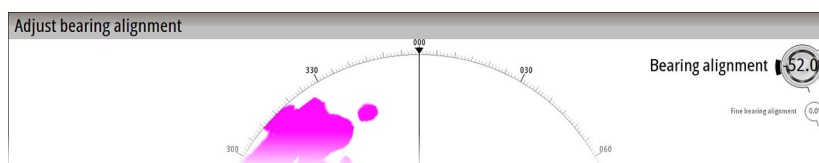

Sector blanking

If the radar is installed in close proximity to a mast or structure, that could cause unwanted reflections or interference to appear on the radar image. Use the sector blanking feature to stop the radar from transmitting in the direction up to four sectors.

- **Note:** Sectors are setup relative to the heading line of the radar. The bearing of the sector is measured from the front of the vessel to the center line of the sector.

Sidelobe suppression

Occasionally false target returns can occur adjacent to strong target returns such as large ships or container ports. This occurs because not all of the transmitted radar energy can be focused into a single beam by the radar antenna, a small amount energy is transmitted in other directions. This energy is referred to as sidelobe energy and occurs in all radar systems. The returns caused by sidelobes tend to appear as arcs.

When the radar is mounted where there are metallic objects near the radar, sidelobe energy increases because the beam focus is degraded.

The increased sidelobe returns can be eliminated using the Sidelobe suppression option. With dialog open:

- Press the rotary knob to switch focus between the manual and auto adjustment icons
- Turn the rotary knob to adjust the value of the active icon

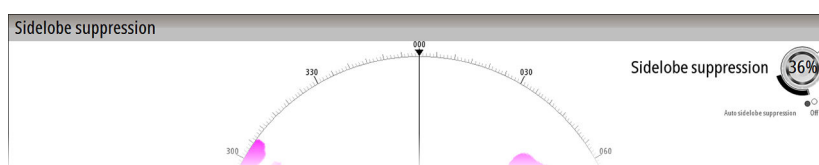

Use the following procedure to adjust the sidelobe suppression:

1. Set the radar range to between 1/2 nm to 1 nm and the Sidelobe suppression value to Auto
2. Take the vessel to a location where sidelobe returns are likely to be seen. Typically this would be near a large ship, container port, or metal bridge
3. Traverse the area until the strongest sidelobe returns are seen
4. Change Auto sidelobe suppression to OFF then select and adjust the sidelobe suppression control until the sidelobe returns are just eliminated. You may need to monitor 5-10 radar sweeps to be sure they have been eliminated
5. Traverse the area again and readjust if sidelobes returns still occur
6. Press the **ENT** key to save the settings and leave the Sidelobe suppression dialog

Tuning

The Tuning options are used to do initial tuning of the radar system. The tuning should be performed in an area with large and identifiable targets within range, and the value should be adjusted until the best deflection is obtained.

With the Tune dialog open:

- Press the rotary knob to switch focus between the manual and auto adjustment icons
- Turn the rotary knob to adjust the value of the active icon

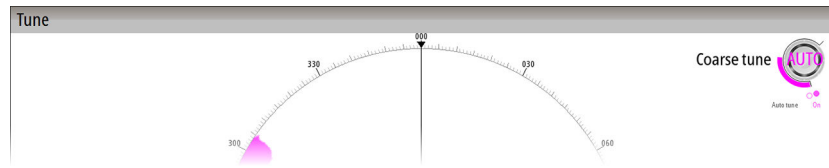

Local interference rejection

This is the start of your concept.

Open array park angle

The park angle is the final resting position of the antenna relative to the heading line of the radar when the radar is set to standby. The antenna will stop rotating at the desired offset.

Halo light

Controls the levels of the Halo Radar pedestal blue accent lighting. There are four levels possible for the lighting. The accent lighting can only be adjusted when the radar is in standby mode.

→ **Note:** The blue accent pedestal lighting might not be approved for use in your boating location. Check your local boating regulations before turning the blue accent lights ON.

Reset radar to factory defaults

Clears all user and installer settings applied to radar, and restores ex-factory settings. Use with caution, taking note of current settings first, especially those set by the operator if radar has already been in active service.

Radar palettes

Different palettes are available for the radar video and for the target trails.

→ **Note:** The palette color does only affect day colors. Night colors are automatically selected when the brilliance are adjusted to 80% or lower.

View from left

→ **Note:** This option is available for the R2009 control unit only.

Used for optimizing the display for viewing from the left. See "*Viewing angle*" on page 37.

Own ship

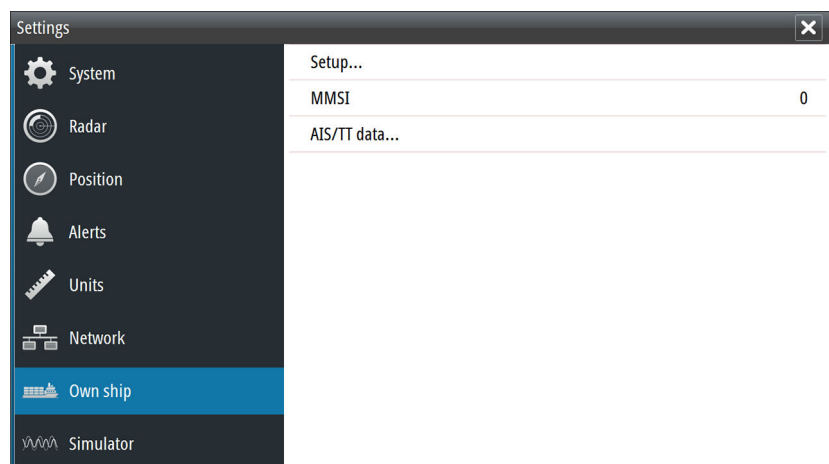

Own ship setup

This dialog is used for defining the CCRP and GPS sensors position.

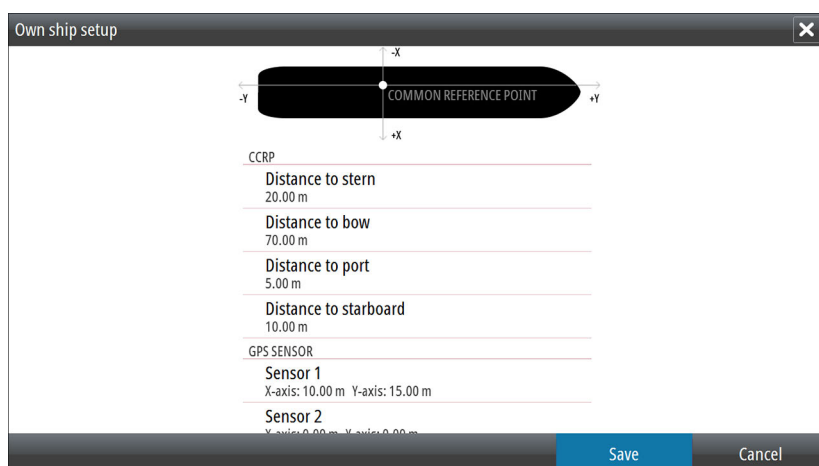

- CCRP
 - Sets the approximate location for the common reference point. This is the ship's bridge and location of the radar operator. With the radar antenna position also defined, the radar can calculate the bearing and distance of radar targets relative to the CCRP.
- GPS Sensor
 - Sets the approximate location for the primary GPS position sensor. This is relevant to correct positioning of AIS targets on the PPI.

MMSI

Set the vessel's own MMSI number. This prevents the vessel being identified as an AIS target on own display.

AIS/TT data

The Vessels dialog displays a list of all tracked targets by distance to own vessel. The list allows for sorting the targets based on target name.

Name	Distance Bearing	CPA TCPA	Type Status
258347500	-	-	AIS lost
277380000	0.86 NM 170 °T	-	AIS safe
AGATHE	137 m 160 °T	-	AIS safe
FFS ACHILLES	0.55 NM 140 °T	-	AIS safe
FISKEBOEN	0.83 NM 163 °T	-	AIS safe
LOS 117	0.71 NM 155 °T	-	AIS safe
MERSEY	0.57 NM 109 °T	-	AIS safe
MISIMA	0.44 NM 187 °T	-	AIS safe

Sort Name View All Close

12

Simulator

The simulation feature lets you see how the unit works in a stationary position and without being connected to sensors or other devices.

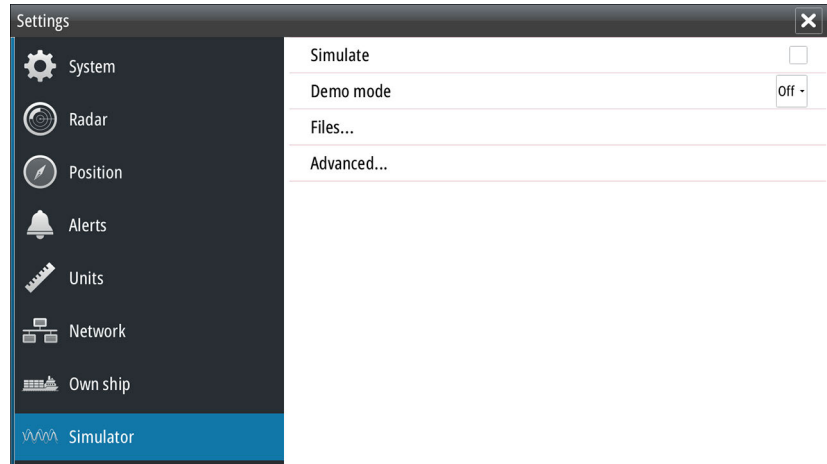

Demo mode

In this mode the unit automatically runs through the main features of the product; it changes pages automatically, adjusts settings, opens menus, etc.

→ **Note:** Demo mode is designed for retail/showroom demonstrations.

Simulator source files

You can select which data files are used by the simulator. A set of source files is included in your system, and you can import files by using a card inserted into the card reader. You can also use your own recorded log data files in the simulator.

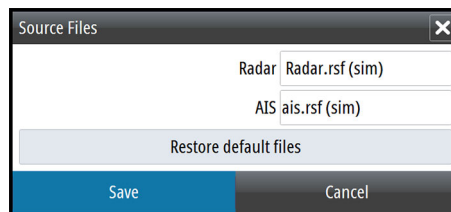

Advanced simulator settings

The Advanced simulator settings allows for manually controlling the simulator.

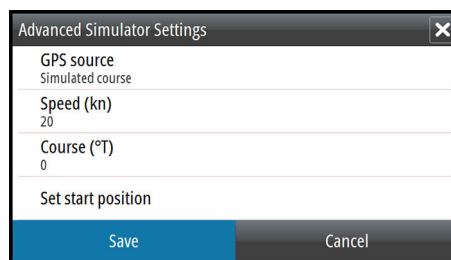

GPS source

Selects where the GPS data is generated from.

Speed and Course

Used for manually entering values when GPS source is set to Simulated course. Otherwise, GPS data including speed and course come from the selected source file.

Set start position

Moves your vessel to the current cursor position.

→ **Note:** This option is only available when the GPS source is set to Simulated course.

13

Maintenance

Preventive maintenance

The unit does not contain any field serviceable components. Therefore, the operator is required to perform only a very limited amount of preventative maintenance.

It is recommended that you always fit the supplied protective sun cover when the unit is not in use.

Cleaning the display unit

A proper cleaning cloth should be used to clean the screen, where possible. Use plenty of water to dissolve and take away salt remains. Crystallized salt may scratch the coating if using a damp cloth. Apply minimal pressure to the screen.

Where marks on the screen cannot be removed by the cloth alone, use a 50/50 mixture of warm water and isopropyl alcohol to clean the screen. Avoid any contact with solvents (acetone, mineral turpentine, etc.), or ammonia based cleaning products, as they may damage the anti-glare layer or plastic bezel.

To prevent UV damage to the plastic bezel, it is recommended that the sun cover be fitted when the unit is not in use for an extended period.

Cleaning the media port door

Clean the media port door regularly to avoid salt crystallization on the surface, causing water to leak into the card slot.

Checking the keys

Make sure that no keys are stuck in the down position. If one is stuck, wiggle the key to free it back to normal.

Checking the connectors

The connectors should be checked by visual inspection only.

Push the connector plugs into the connector. If the connector plugs are equipped with a lock, ensure that it is in the correct position.

NMEA Data logging

All serial output sentences sent over the NMEA TCP connection are logged to an internal file. You can export and review this file for service and fault finding purposes.

The maximum file size is predefined. If you have added several other files to the system (file recordings, music, pictures, PDF files), this may reduce the allowed file size for the log file.

The system logs as much data as possible within the file size limitation, and then it starts overwriting the oldest data.

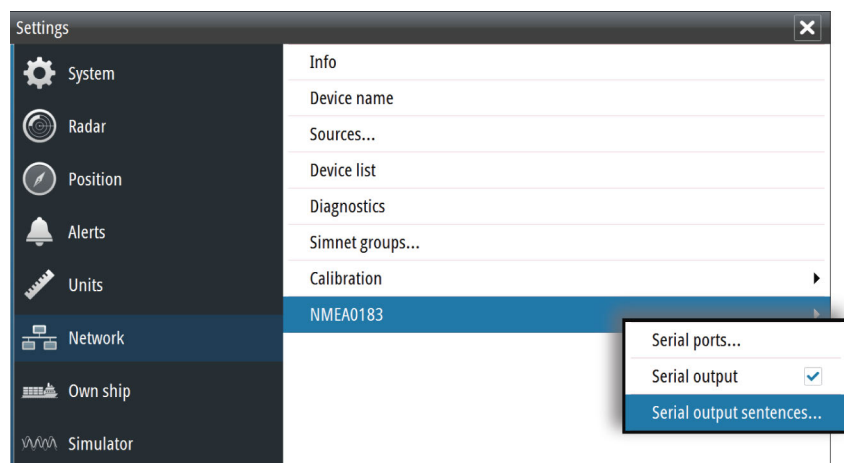

Exporting the log file

The log file can be exported from the files dialog.

When you select the Log database you are prompted to select a destination folder and filename. Once accepted, the log file is written to the chosen location.

Software upgrades

The latest software is available for download from our website, navico-commercial.com/.

Detailed instructions for how to install the software are included in the upgrade files.

Backing up your system data

It is recommended to regularly copy your system settings files as part of your back-up routine. The files can be copied to a card inserted in the card reader. Refer to "*Files*" on page 45.

14

The alert system

The system will continuously check for danger situations and system faults while running.

Type of alerts

There are 3 alert types in the system:

- **Alarms:** This is the system's highest priority alert, activated when situation occurs that might result in collision, or for conditions that critically effect the capability or performance of the system. An alarm is accompanied by an audible signal (3 short signals repeated every 8 seconds), and the alarm icon is flashing until the alarm is acknowledged.
- **Warnings:** This is alerts of lower priority, announcing conditions that could result in unwanted system response or eventual failure if no action is taken. A warning is accompanied by an audible signal (2 short signals repeated every 2.5 minute), and the warning icon is flashing until the warning is acknowledged.
- **Cautions:** This is information about danger and caution objects that requires attention. Caution alerts have no audible signal.

Alert notifications

When an alert is triggered, the alert appears in the Alerts panel. Alarms and warnings remain in the Alerts panel until the reason for the alarm/warning is removed and the alarm/warning has been acknowledged.

The alerts are displayed in a sorted order. The sort order is the severity (i.e. alarm before warning), then age.

Alarms and Warnings have different states:

- Active - not acknowledged, not silenced
- Active - not acknowledged, silenced
- Active - acknowledged
- Active - responsibility transferred to another work station
- Rectified - not acknowledged

When a rectified alert is acknowledged it will disappear from the Alerts panel.





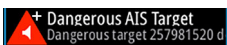
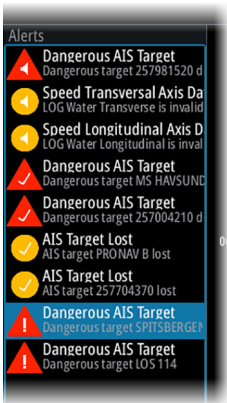

Cautions are not acknowledged, and they disappear from the system when they are rectified. Cautions have therefore only an active state.

A number of related alerts are aggregated and shown in the Alerts panel as one single item with the aggregation symbol next to the alert symbol. The aggregated symbol shows the state as unacknowledged if at least one alert in the aggregated list is unacknowledged. Each alert in the list has to be acknowledged individually.

The table below shows alert icon and behavior depending on if the alert is active, acknowledged, transferred or rectified.



Alert type	Icon	State	Indication
Alarm		Active - not acknowledged, not silenced	<ul style="list-style-type: none"> • Flashing symbol and descriptive text • Audible signal
		Active - acknowledged	<ul style="list-style-type: none"> • Steady symbol and descriptive text • No audible signal
		Rectified - not acknowledged	<ul style="list-style-type: none"> • Flashing symbol and descriptive text • No audible signal

Alert type	Icon	State	Indication
Warning		Active - not acknowledged, not silenced	<ul style="list-style-type: none"> Flashing symbol and descriptive text Audible signal
		Active - not acknowledged, silenced	<ul style="list-style-type: none"> Flashing symbol and descriptive text No audible signal
		Active - acknowledged	<ul style="list-style-type: none"> Steady symbol and descriptive text No audible signal
		Active - responsibility transferred	<ul style="list-style-type: none"> Steady symbol and descriptive text No audible signal
		Rectified - not acknowledged	<ul style="list-style-type: none"> Flashing symbol and descriptive text No audible signal
Caution		Active	<ul style="list-style-type: none"> Steady symbol and descriptive text No audible signal

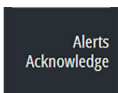

Acknowledging alerts

The **Alerts** softkey is labelled **Alerts Acknowledge** if there is an un-acknowledged alarm or warning in the system.

You acknowledge the most recent alarm or warning by pressing the **Alerts Acknowledge** softkey. The cursor is then automatically moved to the Alerts panel, and you can use the arrow keys to move up and down in the list of alerts.

Repeat pressing this softkey to continue to acknowledge alerts from the top of the Alerts panel. The sort order of alerts is the severity (i.e. alarm before warning), then age.

If no active alerts or warnings are present, the softkey is labelled **Alerts**. Pressing this key moves the cursor to the Alerts panel.

Press the **EXIT** key to exit the Alerts panel.

When an Alarm or Warning is acknowledged, the alert icon stops flashing and changes to the acknowledged icon. The siren continues to sound if there are remaining unacknowledged alarms or warnings, otherwise it is muted.

The acknowledged alert is not moved to its new position in the sort order until there has been 2 seconds without any alerts being acknowledged.

All alerts remain in the Alerts panel until the reason for the alarm is rectified.

The Alerts dialog

The Alerts dialog includes a list of active alerts together with a historic listing of the last 100 alerts. All alerts in the Alerts dialog include a time stamp.

Active Alerts	
No GPS fix raised	2:57 pm 09/15/2015
No GPS fix raised	1:36 pm 09/11/2015
No GPS fix raised	2:38 pm 09/10/2015
Alerts History	
No GPS fix raised	11:31 am 08/07/2015
No GPS fix cleared	1:30 pm 08/03/2015
No GPS fix raised	1:30 pm 08/03/2015
No GPS fix raised	9:35 am 07/31/2015
No GPS fix raised	7:26 am 07/15/2015

An alert is moved to the historic listing after the alert is removed from the Alerts panel.

Alphabetic alarm listing

Alert type abbreviations:

- C: Caution
- W: Warning
- A: Alert

Alert text	Description	Alert type
AIS Capacity 95%	AIS target processing/displaying is about to be exceeded.	C
AIS Capacity Full	AIS capacity exceeded.	W
AIS FAIL	AIS failure	C
AIS FAIL	Not used AIS failure	C
AIS TGT in GZ	AIS Target in Guard zone	W
AIS TGT Lost: #	AIS target # is lost	W
AZI FAIL	Radar antenna failure	W
BAM HBT Lost	BAM Heartbeat lost	C
Dangerous AIS TGT	CPA or TCPA values of an activated AIS target less than set limits	A
Dangerous TT	CPA or TCPA values of a tracked target less than set limits	A
EPFS FAIL	Not used position source failure	C
EPFS FAIL	Position source failure	W
Geodetic Datum FAIL	Geodetic Datum failure	W
GYRO FAIL	Gyro failure	W
GYRO FAIL	Not used gyro failure	C
HDG FAIL	Heading marker failure	W
Magnetron EOL	Magnetron end of life reached	C
POSN Invalid	Position invalid	W
POSN Unavailable	Position unavailable	W
RADAR FAIL	Radar TXRX failure	W
REF TGT Lost	Reference target lost	W
SOG FAIL	Speed Over Ground failure	W
Speed LOG FAIL	Not used speed LOG failure	C
Speed LOG FAIL	Speed LOG failure	W

Alert text	Description	Alert type
SPD Long. Axis FAIL	Speed longitudinal axis data failure	W
SPD Tran. Axis FAIL	Speed transversal axis data failure	W
STW FAIL	Speed Through Water failure	W
TGT in GZ	Tracked target # within the vessel's guard zone	W
Train TGT CPA FAIL	Training target CPA out of range	W
Train TGT TCPA FAIL	Training target TCPA out of range	W
TRIG FAIL	Trigger failure	W
TT Capacity 95%	Tracked target processing/displaying is about to be exceeded	C
TT Capacity Full	Tracked target capacity exceeded.	W
TT Lost: #	Tracked target # is lost	W
UTC Data FAIL	UTC data failure	W
VID FAIL	Radar video failure	W

Operating modes fallback

The following table shows possible failure categories, and which operations that are allowed or not allowed when the failure occurs.

Category	Fallback possible	Fallback impossible
GYRO FAIL	Only RM HUP presentation	<ul style="list-style-type: none"> • AIS • Acquiring/Tracking Radar Targets • Presenting Geographical/Dead Reckoning • Maps
Speed LOG FAIL *	Only RM	<ul style="list-style-type: none"> • True vector • Dead Reckoning Map
EPFS FAIL Geodetic Datum FAIL POSN Invalid	<ul style="list-style-type: none"> • Video display • Radar target • Radar presentation 	
VID FAIL AZI FAIL TRIG FAIL	<ul style="list-style-type: none"> • All the presentation (RM/TM etc) • AIS • Maps 	
HDG FAIL	<ul style="list-style-type: none"> • All the presentation (RM/TM etc) • AIS • Maps 	Acquiring/Tracking Radar Targets
AIS FAIL	<ul style="list-style-type: none"> • AIS timeout • VTG timeout 	AIS presentation and AIS anti-collision checks

* The EFPS can operate as source of log speed

15

Terms and abbreviations

ACK	Acknowledge
ACQ	Acquire
AZ	Acquisition Zone
ADJ	Adjust, Adjustment
ALT	Altitude
AIS	Automatic Identification System
AM	Amplitude Modulation
ANCH	Anchor Watch
ANT	Antenna
AP	Autopilot
APR	April
ARPA	Automatic Radar Plotting Aid
AUD	Audible
AUTO	Automatic
AZ	Acquisition Zone
AZI	Azimuth Indicator
BCR	Bow Crossing Range
BCT	Bow Crossing Time
BKGND	Background
BRG	Bearing
BRILL	Display Brilliance
BWW	Bearing Waypoint To Waypoint
C UP	Course Up
CCRP	Consistent Common Reference Point
CENT	Centre
CNCL	Cancel
COG	Course Over Ground
CONT	Contrast
CPA	Closest Point Of Approach
CPU	Central Processing Unit
CRS	Course
CTS	Course To Steer
CURS	Cursor
DAY/NT	Day/Night
DECR	Decrease
DEG	Degrees
DEL	Delete
DGPS	Differential Gps
DISP	Display
DIST	Distance
DPTH	Depth
DR	Dead Reckoning
DSC	Digital Selective Calling

DW	Deep Water
EBL	Electronic Bearing Line
ECDIS	Electronic Chart Display And Information System
ECS	Electronic Chart System
EGNOS	European Geo-Stationary Navigational Overlay System
ENC SOG	Automatic Navigational Chart
EP	Estimated Position
EPFS	Electronic Position Fixing System
EPIRB	Emergency Position Indicating Radio Beacon
EQUIP	Equipment
ERBL	Automatic Range And Bearing Line
ETA	Estimated Time Of Arrival
ETD	Estimated Time Of Departure
EZ	Exclusion Zone
FK	User Function Key
FMCW	Frequency Modulated Continuous Wave
FS	Fast Scan
FWD	Forward
GAS	Grounding Avoidance System
GEOG	Geographic
GLONASS	Global Orbiting Navigation Satellite System
GMDSS	Global Maritime Distress And Safety System
GND TRK	Ground Track
GNDSTAB	Ground Stabilized
GNSS	Global Navigation Satellite System
GPS	Global Positioning System
GZ	Guard Zone
H UP	Head Up
HDG	Heading
HL	Heading Line
HR	Hours
I/O	Input/Output
IBS	Integrated Bridge System
ID	Identification
IN	Input
INIT	Initialization
INS	Integrated Navigation System
IR	Interference Rejection
IRCS	Integrated Radio Communication System
ISW	Interswitch
Km	Kilometre
KN	Knots
LBL	Label
LIM	Limit
LOST TGT	Lost Target

LP	Long Pulse
m	Metres
MIN	Minimum
MIN	Minutes
MKR	Marker
MOB	Man Over Board
MP	Medium Pulse
MSTR	Master
N UP	North Up
NAV	Navigation
NC	Normally Closed
NLT	Not Less Than
NM	Nautical Mile
NMT	Not More Than
NR	Noise Rejection
NUC	Not Under Command
OFF CENT	Off Centre
OFFTRK	Off Track
OS	Own Ship
OUT	Output
PAD	Predicted Area Of Danger
PAST POSN	Past Position
PCB	Printed Circuit Board
PI	Parallel Index Line
PL	Pulse Length
PM	Performance Monitor
POSN	Position
PPC	Predicted Point Of Collision
PRF	Pulse Repetition Frequency
PWR	PWR
R BRG	Relative Bearing
R CRS	Relative Course
R VECT	Relative Vector
RAD	Radius
RAIN	Anti Clutter Rain
RCDS	Raster Chart Display System
REF	Echo Reference
REF SOG	Echo Reference Speed
REL or R	Relative
RM	Relative Motion
RM (R)	Relative Motion (Relative Trails)
RM (T)	Relative Motion (True Trails)
RNC	Raster Navigational Chart
RNG	Range
ROT	Rate Of Turn

RR	Range Rings
RTE	Route
RX	Receiver
SAF CON	Safety Contour
SAR	Search And Rescue
SC/SC	Scan To Scan
SDME	Speed and Distance Measuring Equipment
SEA	Anti Clutter Sea
SEL	Select
SENC	System Electronic Navigational Chart
SNR	Signal To Noise Ratio
SOG	Speed Over Ground
SP	Short Pulse
SPD	Speed
SRNC	System Raster Navigational
STAB	Stabilized
STBD	Starboard
STBY	Standby
STW	Speed Through Water
T BRG	True Bearing
T CRS	True Course
T SPD	True Speed
T VECT	True Vector
TB	Target Boost
TCPA	Time To Closest Point Of Approach
TE	Target Expand
TGT	Target
Tgt exp	Target expansion
Th	Target threshold
TM	True Motion
TPR	Transponder
TRIAL	Trial Maneuver
TRIG	Trigger Pulse
TRK	Track
TRKG	Tracking
Tracking	Time To Go
TS	Target separation
TWOL	Time To Wheel Over Line
TX	Transmit, Transmitter
TX/RX	Transceiver
UPS	Uninterruptible Power Supply
VRM	Variable Range Marker
VTS	Vessel Traffic Services
WOL	Wheel Over Line
WOP	Wheel Over Point

16

Spare parts and accessories

The most up-to-date list of spare parts and accessories is available at the product site on navico-commercial.com/.

R2009 Options and accessories

Item	Part number
O2000 Control unit	000-12189-001
Micro-C T-connector	000-0119-79
NMEA 2000 Cable, 1.8 m (6 ft)	000-0127-53
NMEA 2000 Cable, 4.6 m (15 ft)	000-0119-86
NMEA 2000 Power cable	000-0119-75
NEP-2 Network expansion	000-10029-001

R2009 Spare parts and service packs

Item	Part number
O2000 Control unit	151-10369-001
R2009 Control unit	151-10366-001
Sun cover	000-12413-001
Front case service pack	000-12398-001
Keypad radar kit	000-12401-001
SD service pack	000-12402-001
Case re-assembly kit	000-12403-001
SD door kit	000-12407-001
Dash mounting pack	000-12409-001
Bracket mounting pack	000-12411-001
NMEA 0183 serial cable, 2 m (6.6 ft)	000-11247-001
Power cable	000-00128-001

R3016 Options and accessories

Item	Part number
O2000 Control unit	000-12189-001
HDMI-DVI cable, 1.5 m (5 ft)	000-12427-001
Micro-C T-connector	000-0119-79
NMEA 2000 Cable, 1.8 m (6 ft)	000-0127-53
NMEA 2000 Cable, 4.6 m (15 ft)	000-0119-86
NMEA 2000 Power cable	000-0119-75
NEP-2 Network expansion	000-10029-001

R3016 Spare parts and service packs

Item	Part number
O2000 Control unit	151-10369-001
R3016 Control unit	151-10368-001
Sun cover	000-12414-001
Front case service pack	000-12399-001
Keypad radar kit	000-12401-001
SD service pack	000-12402-001
Case re-assembly kit	000-12404-001
SD door kit	000-12408-001
Dash mounting pack	000-12410-001
Bracket mounting pack	000-12412-001
High speed NMEA 0183 serial cable, 2 m (6.6 ft)	000-12393-001
Power cable	000-00128-001

17

Technical specifications

For updated technical specifications, compliance and certifications, refer to the product website.

Overview	
Display size	
R2009	9-inch portrait
R3016	16-inch widescreen
Screen brightness	
R2009	≤1200 cd/m ²
R3016	300 cd/m ²
Networking capability	
R2009	2 x NMEA 0183, 1x NMEA 2000, 1x Ethernet
R3016	4 x NMEA 0183, 1x NMEA 2000, 1x Ethernet
Video integration	
R2009	None
R3016	1x HDMI output (Supported resolutions: 1366 x 768)

Display	
Display resolution	
R2009	480 x 800
R3016	1366 x 768
Display type	
R2009	9-inch LED-backlit Colour TFT LCD
R3016	16-inch LED-backlit Colour TFT LCD

Technical/environmental	
Operating temperature	-15°C to +55°C / 5°F to 131°F
Waterproof standard/rating	IPX6 and IPX7
Specified standards	<ul style="list-style-type: none"> IEC/EN60945 <p>→ Note: Refer to the product website for the latest information about product compliance.</p>
Dimensions	Refer to "" on page 0
Weight	
R2009	1.95 kg / 4.3 lb
R3016	4 kg / 8.8 lb

Power	
Supply voltage	12-24 V DC
Power consumption	
R2009	11 W
R3016	20 W

Compass safe distance

	Safe distance to the standard magnetic compass	Safe distance to the steering magnetic compass
R2009 Control unit	0.34 m	0.25 m
R3016 Control unit	0.65 m	0.43 m

18

Menu tree

The illustration below shown the main menu and the first level sub menus.

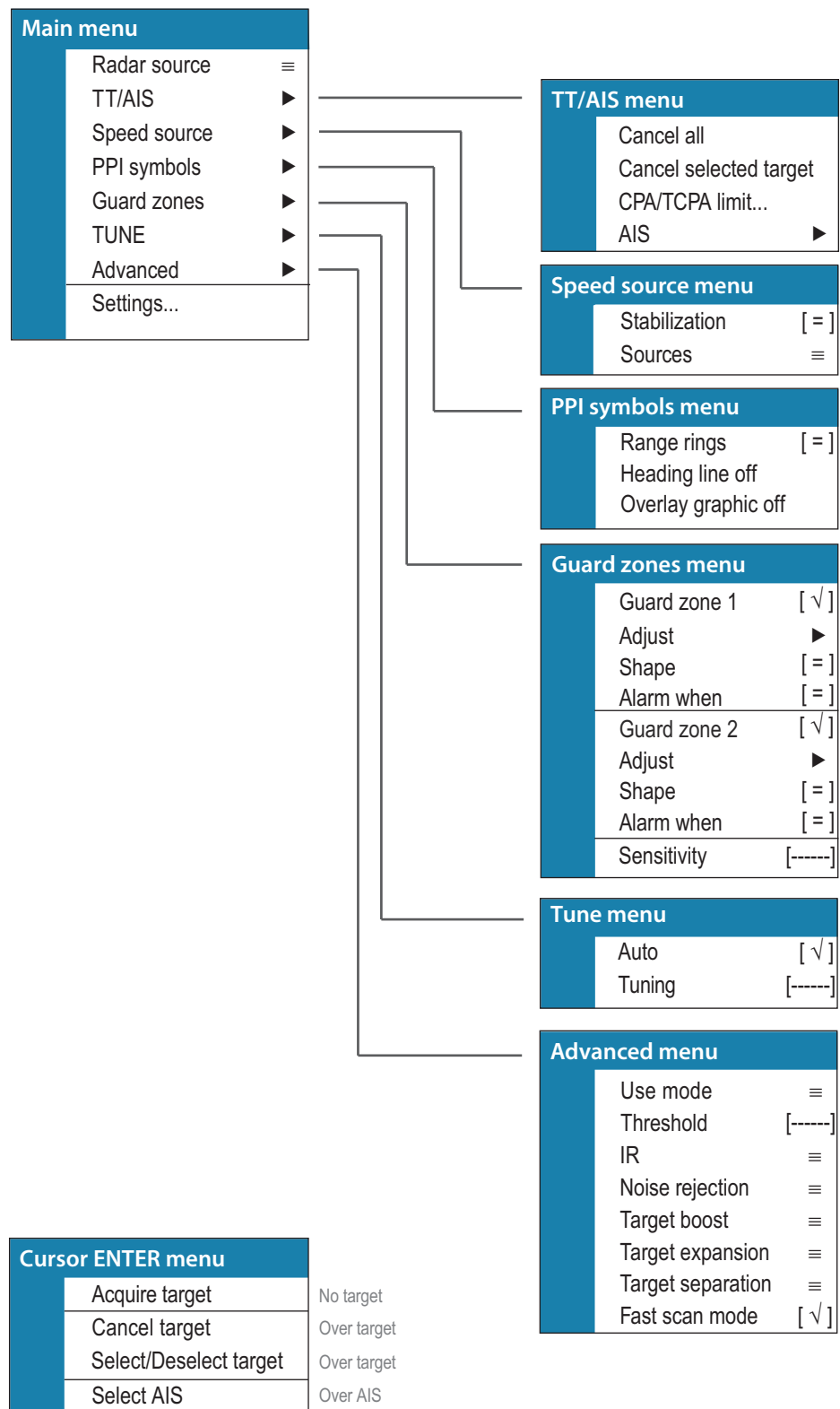

19

Dimensional drawings

R2009 Control unit

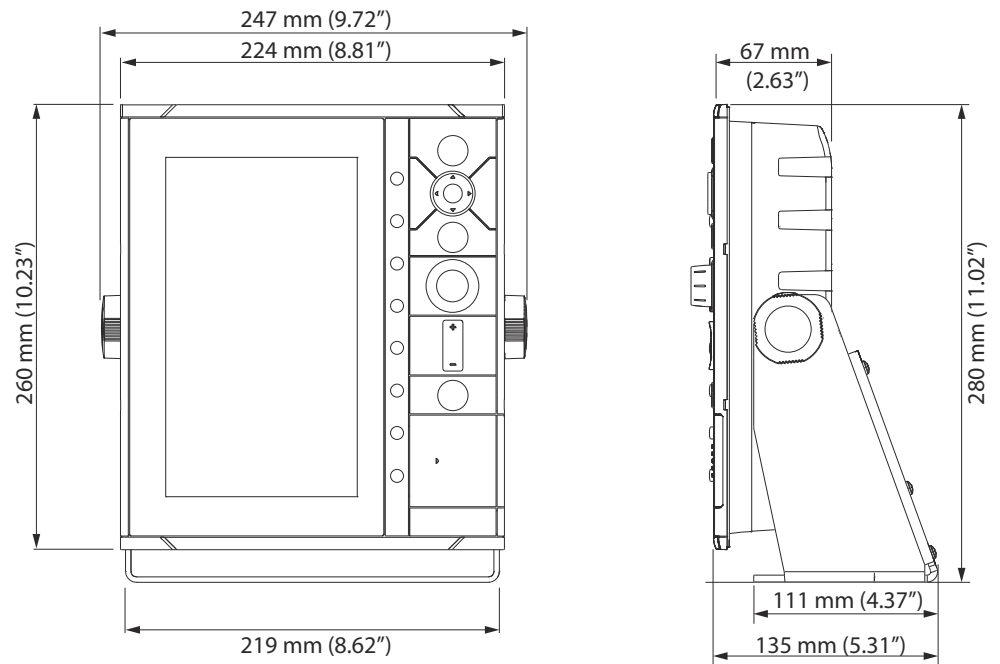

R3016 Control unit

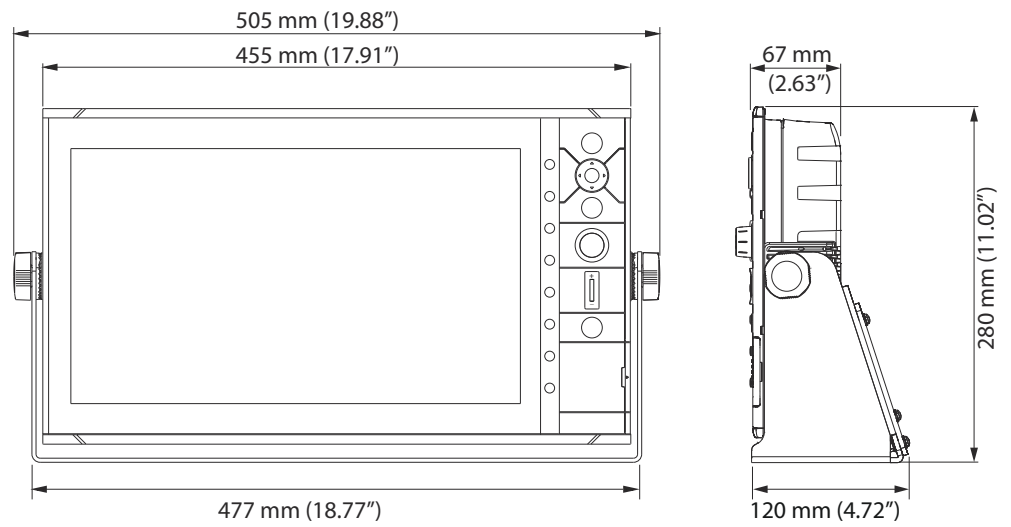



SIMRAD